

**RCM**

**Broadcast News**

Volume No. 141, March 1969



Previewing 10-Station Antenna System . . .  
New Silhouette in the Chicago Sky

# A modest miracle from RCA...

or how to get  
more VTR  
for your money

The TR-60. The only thing modest about this unique studio and mobile VTR is the price. It's lower. But it's capable of superior performance! What's the secret? An RCA exclusive. 48 years of experience in the broadcast business. The most. With that kind of background, it's easier to make the best for less.

Only RCA could have produced a modestly priced VTR with correct color field editing carried down to a single frame (to avoid color disturbance). **Plus** line-by-line correction of hue and saturation error with (optional) "CAVEC" for life-like playback reproduction. **Plus** a rear side erase head that makes tape scratching impossible. **Plus** total remote control over editing sessions. **Plus** in-phase color dropout correction (optional) that puts the right color back in the picture. **Plus** reactance and resistance controls that give you more uniform color. Leave it to RCA to get all the imperfections out of the VTR color picture . . . and, for less money.

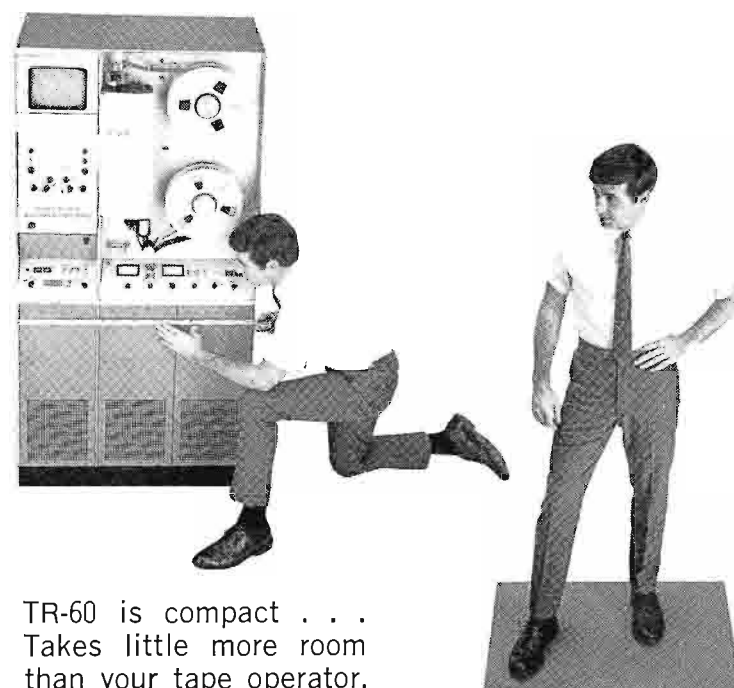
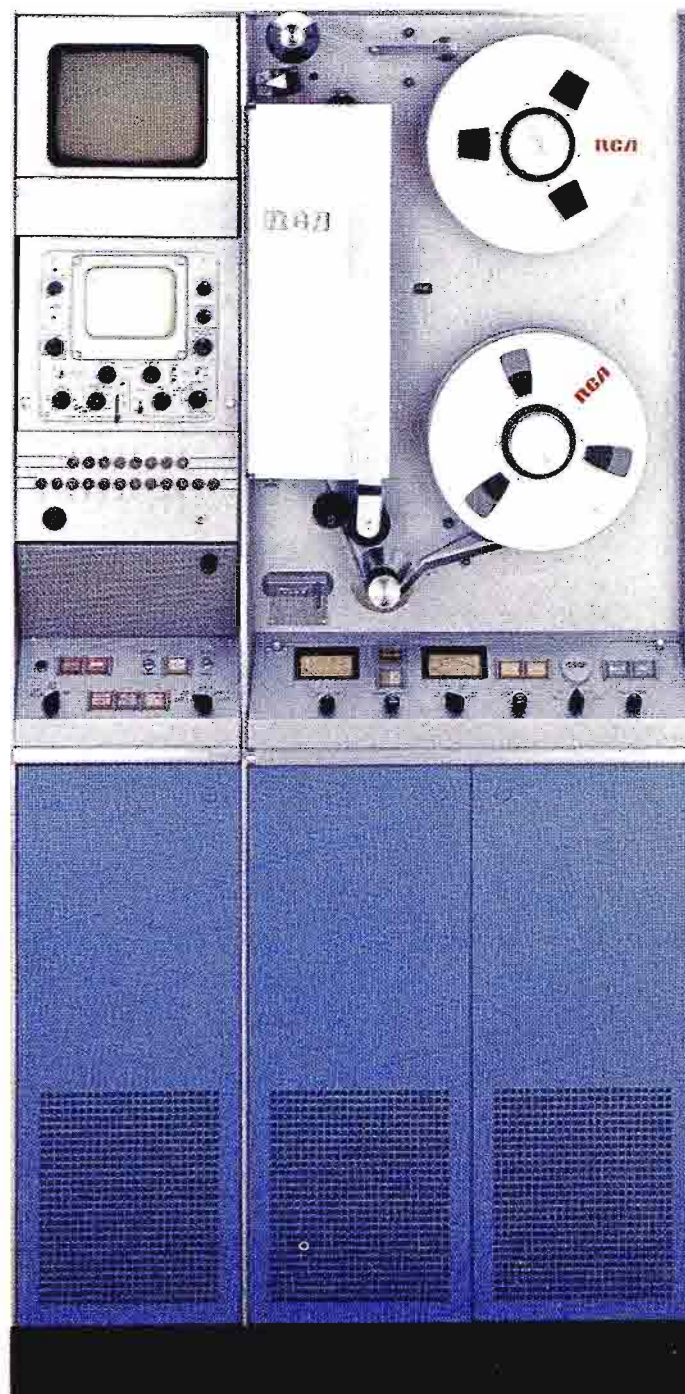

TR-60 is compact . . .  
Takes little more room  
than your tape operator.

**RCA** Broadcast  
Equipment

# **RCA** Broadcast News

---

Published by BROADCAST SYSTEMS DEPARTMENT  
RCA COMMERCIAL ELECTRONIC SYSTEMS DIVISION

## CONTENTS

---

Apollo 8 Camera Orbits Armchair Viewers . . . . .	4
Big John Blankets Chicago . . . . .	8
ETV in Glasgow Teaches Teachers . . . . .	14
Twenty-Four Hour Parts Service . . . . .	18
Transmission Line — The Inside Story . . . . .	24
Radio Télévision Nationale Congolaise . . . . .	26
In the TR-70B — the “B” is for Brains . . . . .	32
How to Get the Best Color from Your TK-42/43 . . . . .	36
Products in the News . . . . .	42
Four New Low Cost PTV Color Cameras . . . . .	46

---

PRICE . . . single copies. \$2.50 each

*Copyright 1969 Radio Corporation of America, All Rights Reserved*

## RCA Puts New Trademark On Famed New York Landmark

The world's highest sign was transformed when RCA unveiled its new trademark in place of the older set of company initials atop the RCA Building at 30 Rockefeller Plaza, on November 15, 1968.

One of New York's most famous landmarks for the past 31 years, the RCA sign towers 850 feet above mid-town Manhattan and can be seen for miles around on a clear night. The replacement of the initials by the new trademark highlights the company's new corporate identification program.

The replacement of the old letters with this bold contemporary design is intended to convey the spirit of growth and vitality that characterize RCA.

More than a mile of 15mm glass tubing in double rows trace the perimeter of the letter forms. The outer row of the tubing arrangement is an auxiliary system which lights automatically should any primary section fail to light. Under high voltage, the neon gas-filled tubing gives forth rays of a bright orange-red color.

The new RCA trademark is the most prominent feature of a far-reaching design program affecting every aspect of the company's appearance and of product design. It has involved simplifying the names of various RCA divisions, subordinating or eliminating secondary trademarks used on company products.

The program is intended to establish a consistent and modern style extending to all RCA activities and facilities, creating a single family resemblance that will enable each to be associated immediately and unmistakably with RCA.



## Stations Can Now Obtain Long Term Leasing of Broadcast Equipment

RCA Commercial Electronic Systems Division and Systems Capital Corp., (SCC) have arranged to make RCA radio and television broadcast equipment available under individualized leasing arrangements for periods up to ten years, with no down payments.

Barton Kreuzer, Vice President and General Manager of the RCA Commercial Electronic Systems Division, said that the agreement represents a milestone in broadcast equipment financing.

"Station owners now have a unique means of acquiring all necessary operating equipment at the lowest possible initial investment, as well as great flexibility of lease payment plans," he said. "For example, a television station operator may lease his entire technical facilities, including such major items as color cameras, TV tape recorders, transmitters and terminal equipment, without the usual heavy

cash outlay. Under an SCC Plan, he may arrange lease payments which may be very low, initially, and escalate over the years."

Robert W. Rader, Vice President of Systems Capital, who is in charge of the firm's communications equipment leasing activities, said that under certain conditions the purchaser may add or substitute equipment during the life of the lease. At the expiration of the lease, the station operator may purchase the equipment at the current fair market value.

Mr. Rader added that a long-term leasing program has already been successfully implemented for Philadelphia-based U.S. Communications Corporation. USCC, which owns six UHF television stations, has completed leasing arrangements with SCC for a total of approximately \$9,000,000 worth of television equipment and facilities.

Systems Capital Corp., headquartered in Philadelphia, also has administrative offices in Phoenix, Ariz., Los Angeles, Calif., and London.

## Nation's Second 110KW Transmitter On Air

On February 1 the nation's second 110kW transmitter began operation in Pittsburgh's first independent commercial UHF station, WPGH, Channel 53. WPGH joins the growing group managed by U.S. Communications, Inc., which also operates WPHL, Philadelphia; WXIX, Cincinnati; KEMO, San Francisco; and has under construction another UHF station in Atlanta.

Dedication ceremonies at WPGH featured a talk by FCC Commissioner Robert E. Lee. Also present were the chain's principals: Dr. Frank J. Reichel, Jr., Chairman of the Board; Robert McGredy, President; Richard Rawls, General Manager (WPGH-TV); and Robert Leach, Director of Engineering.

Based on performance experience with the TTU-110 transmitter at Channel 17 in Philadelphia, the U.S. Communications, Inc., management team has become a firm proponent of high signal density as a way to bring audiences crisp color pictures—without need for special receiving antennas.

Two additional events in the growth of U.S. Communications, Inc., are the granting of a "CP" for a Rosenberg/Houston facility and the delivery of another TTU-110 transmitter for the Atlanta "U".

## Indiana U Plans TV Network To Link State Medical Facilities

At Indianapolis, Indiana University Medical Center is pioneering a statewide medical instruction television network. When completed it will serve hospitals in Bloomington, Lafayette, Muncie, Terre Haute, Evansville, Hammond-Gary, South Bend and Fort Wayne, as well as the on-campus dental college and nursing school which are already interconnected by closed circuit television.

Plans call for 2500 MHz transmitters at each of the above locations to feed instructional materials to medical undergraduates, and refresher programs to practicing physicians. The educational series is generated by the Regional Medical Education Program.

As a part of this expansion program, the Medical Center has increased tape production by the addition of a TR-60 High Band Color Tape Recorder. This will facilitate the exchange of taped programs among state hospitals which are already equipped with color VTR's and monitors.

The new network will also be able to transmit program materials to the Indiana Higher Education Television Network (Purdue University, Indiana University, Ball State University) over the existing two-way video links.

An elaborate switching complex at the Medical Center controls the dispatching of programs to and from any of the interconnected locations—with an audio feedback from all receiving locations, permitting questions and answers.

## Major New Video Tape Production Center Being Readied in New York City

Overall system responsibility for one of the world's most advanced tape production centers has been assigned to RCA. The \$3 million center, LewRon Television, Inc.'s newest facility is under construction at the former Con Ed building on West 53rd Street in New York City.

Included in the comprehensive system are the following RCA products: three TK-44A color cameras, custom-built TS-40 switching equipment, 20-input audio production console, and color film chain with 16mm and 35mm capabilities.

Only the outer walls of the 53rd Street site have been retained. Otherwise the entire structure is new. When opened in the Spring the LewRon center will house two large studios totaling 9,000 square feet, Production and Post-Production areas and complete tape and film editing facilities. LewRon clients can also avail themselves of five completely equipped mobile VTR units.

## New RCA Automated Control System Set For Puerto Rico's WRIK-TV

The first of RCA's new systems for semi-automatic control of video/audio programming is being readied at the Camden plant for WRIK's new studios at San Juan. Called Vid-Au-Mac, the system handles up to four hours of television programming (as many as eighty program sequences) by "memorizing" instructions for selecting program sources in a pre-determined sequence and for turning on and off devices that handle them. The memory consists of stacks of ferrite cores identical to those used in computers.

The New York City facility will give LewRon production capabilities on three coasts. LewRon already has studio and remote facilities operating in Los Angeles and production capabilities in Florida.

LewRon Television, Inc., principals are R. Spangler, president; L. Lewman, vice-president; S. Cole, vice-president and chief financial officer.

## Two Texas TV Stations Raise TFU-45J Pylon Antennas

RCA TFU-45J Pylon Antennas, members of the most popular family of UHF-TV antennas, were raised by KKBC and KSEL in Lubbock, Texas.

The KSEL antenna has an omnidirectional pattern for operation on Channel 28, with customized gain provided by increasing the antenna layers. The KKBC Channel 34 antenna is a custom type TFU-45JDA with a directional "peanut" radiation pattern. The TFU-45J series of antennas is the most recent addition to the UHF Pylon Antennas offered by RCA.

At WRIK, Vid-Au-Mac will be integrated with an RCA master control. Other equipments ordered by the station are: Three TK-42 color cameras, two TR-60 color video tape recorders, two film systems, TK-27 and TK-22, and two TS-40 switching units.

By automating operational routines associated with programming, Vid-Au-Mac is expected to free key personnel for more creative duties and virtually eliminate switching errors that often show up in the home as "blank screens".

WRIK's president is Alfredo R. de Arellano III (center, below). Billy J. Clark (left) is director of engineering for Island Network.



## Thirteen Stations Buy New "Maxim-Air" TV Transmitter



The first major TV transmitter development in over 15 years, the RCA TT-30FL, 30 kW VHF TV Transmitter, provides finest color TV and near-perfect on-air reliability—at greatly reduced operating costs. Upcoming installations include: Pittsburgh, Chicago, San Francisco, Springfield, Spokane, Charlotte, Baltimore, Denver and St. Louis.

This totally new concept in solid state design reduces the number of operating tubes by over 180. The finest in TV color transmission is achieved through the use of advanced solid state circuitry with only 10 tubes. In fact, this transmitter generally exceeds previous performance specifications by 2 to 1.

Dollar-saving features are: Reduced floor space requirements (only 145 sq. ft.) greatly reduced cooling requirements, (1½ h.p. blower motor vs 7 h.p.) and miniscule tube inventory (3 tube types). Near perfect on-air reliability results from use of two parallel 15-kW transmitters, a "hot" standby exciter, and long-life solid state components.

Additional features include the use of components well below their operational ratings; motor-driven controls and remote metering of all major adjustments; and unattended/remote control to meet proposed FCC requirements. As a matter of record, the TT-30FL will operate within specifications without adjustment for 30-day intervals. Furthermore, its operation can be computer controlled.

### NEW EDITORIAL FEATURE

"Products in the News" is a new feature appearing for the first time in the current issue beginning on page 42.

Broadcasters can look to this section for capsule descriptions of additions to the RCA product line which may answer a vital station need and contribute significantly to overall operational efficiency.

# RCA TV CAMERA ON APOLLO 8 ORBITS ARMCHAIR VIEWERS 'ROUND THE MOON

When men for the first time in history orbited the moon during December 1968, millions of TV viewers around the world journeyed vicariously with them through the eye of a 4½ pound TV camera on board the spacecraft. The portable camera provided a "fourth" seat in the Command Module enabling the home audience to monitor the three American astronauts at work inside their spaceship, during the ½ million mile round trip, and to enjoy a spaceman's view of the moon and the earth. This tiny camera, small enough to fit in the glove compartment of a car, is an exact duplicate of the RCA camera which sent back the live TV pictures during the Apollo 7 earth orbit in October. It was developed by RCA for the National Aeronautics and Space Administration to enable armchair explorers to view this historic space happening.

## TV System

The Apollo TV system consists of the portable TV camera on board Apollo 8, and electronic signal processing equipment (scan converters) at Merritt Island, Florida; Goldstone, California; and Madrid, Spain. The TV camera and ground equipment were produced by the RCA Astro-Electronics Division, Princeton, N. J.

The camera was built under contract to North American Rockwell, Inc., prime contractor to NASA's Manned Spacecraft Center for the Apollo Command Module. The scan converters were built under contract to NASA's Goddard Space Flight Center, which manages the Flight Network.

## TV Camera

The tiny RCA camera weighs less than five pounds, including lens. It uses a 160-degree wide-angle lens for on-board monitoring of the Astronauts, and a 100-mm lens for viewing scenes outside the spaceship. The TV signal from the camera was fed into the spacecraft's communication system for transmission to Goldstone or Madrid. There it was received, processed, and relayed to the NASA Manned Spacecraft Center for release to the world's major TV networks. The use of integrated circuits permitted building the small,

lightweight camera that requires only six Watts of power to operate.

## Spacecraft Transmission Link

The TV camera output is fed into a Premodulation Processor where it is frequency multiplexed with voice and telemetry data. The video then feeds into an S-Band antenna system for transmission to earth. For close-to-earth transmission an omni-band antenna is used, for transmission from deep space a high-gain antenna is used.

## Operating Principles

Normally broadcast TV operates with a signal bandwidth of 4½ million cycles. However, because of space limitations, the Apollo system was designed to operate with a ½ million cycle bandwidth. This 9-to-1 reduction in bandwidth results in substantial saving of power—but makes it necessary to reduce TV frame and line rates. Apollo TV is 10 frames per second (compared to 30 for regular TV) and produces a picture with 320 scanning lines (525 for regular TV). The scan converter systems convert the signal from Apollo standards to broadcast scan standards in order to have suitable picture display on home receivers.

Apollo TV in the future will also transmit high-definition "still" photographs for scientific purposes. To accomplish this within the 500 kHz bandwidth requirement, the photographs will be transmitted at a rate of one frame per 1.6 seconds, allowing 1280 lines per frame. The RCA scan conversion system has been designed to compensate for these irregularities in transmission and convert the incoming signals from Apollo to broadcast format.

## Elements of RCA Converter System

(1) TV Display. This consists of 5CK11 flying-spot tube and vertical line wobble to reduce line structure without affecting horizontal resolution. Because of Apollo TV's two scanning rates (10 frames per second, 320 lines per frame, and one frame per 1.6 seconds, 1280 lines per frame), deflection circuits were specially designed to maintain size, centering and linearity when switched between the two scanning rates: a hor-

UNITED STATES

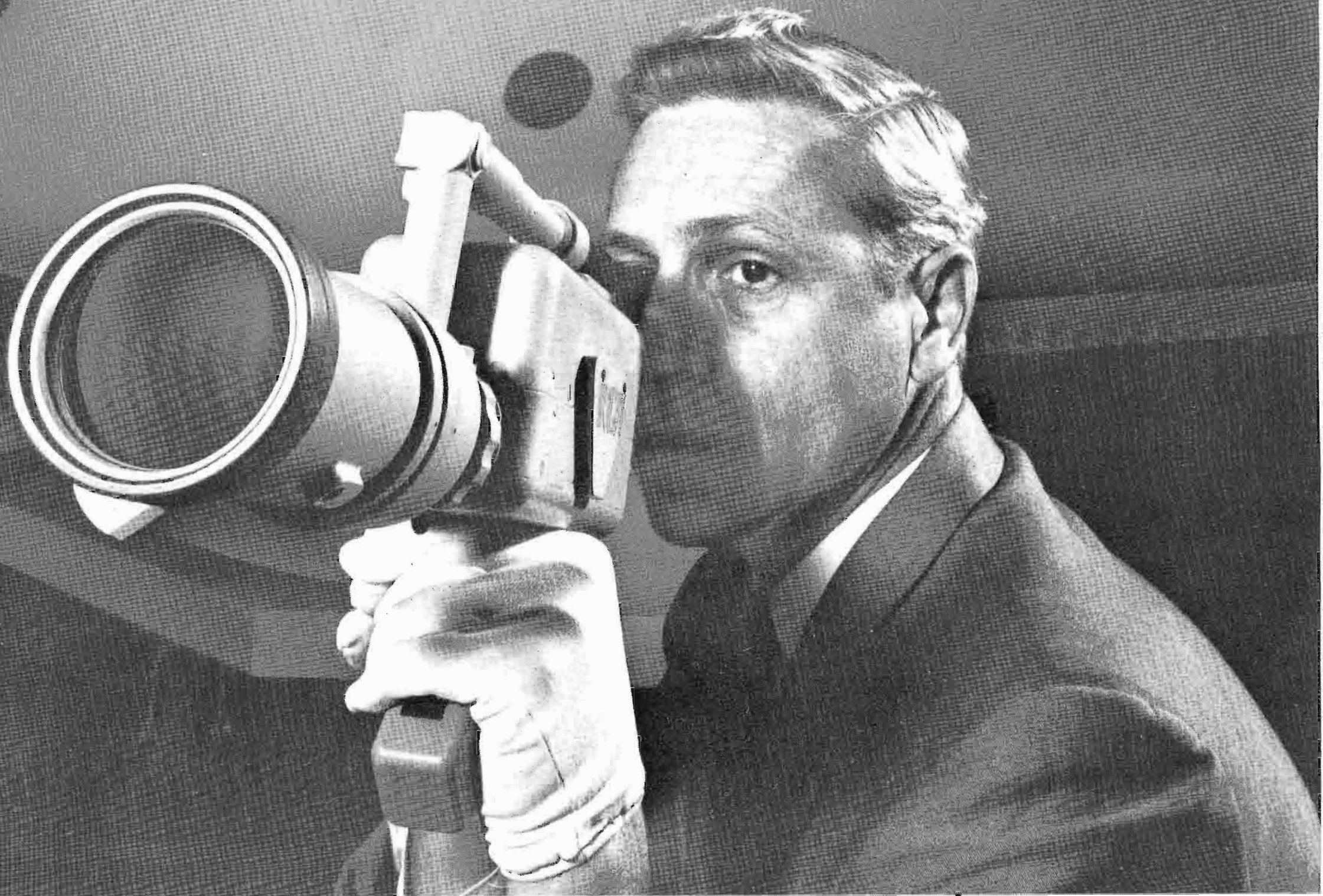

horizontal rate change of 4-to-1 and a vertical rate change of 16-to-1. The 10-frame-per-second (non-interlaced) Apollo TV system uses either conventional pulse-type sync or tone-burst sync at 409.6 KC. The high-definition "still" photograph system uses the tone-burst for its sync.

(2) Vidicon Camera. This is a standard broadcast RCA TK-22 model, modified to accept an external vidicon gating pulse. It also incorporates gamma correction circuitry that is variable to enable operator to place "break points" in the transfer characteristic where desired. The TV camera uses a type 8480 vidicon tube, larger than normal.

(3) Magnetic Disc Recorder. The disc is about 14 inches in diameter and rotates at 3600 revolutions per minute, servo-controlled for long term stability.

(4) Pulse and Timing Units. The RCA system uses a standard sync generator but specially designed sync lock unit and gating generator. Each of these three



FIG. 3 The use of integrated circuits made it possible to produce a 4½ pound miniaturized TV camera. Hundreds of IC's are contained in the black squares on this circuit board from the Apollo camera.

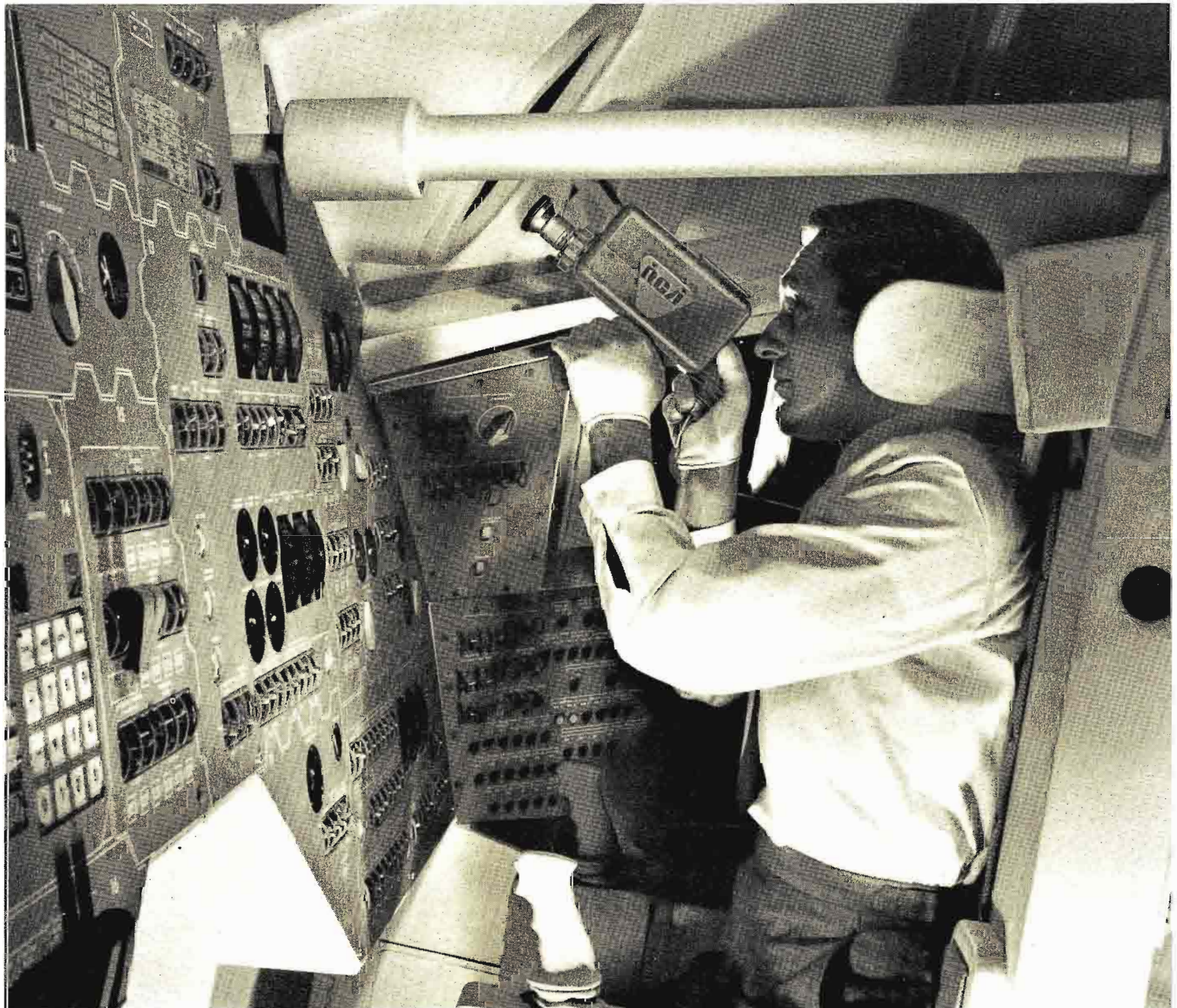



elements is a solid-state device, employing primarily digital logic to obtain desired timing pulses.

### How Scan Converter Works

A TV signal received from Apollo is applied to the TV display, focused on the RCA broadcast vidicon camera, and stored on the photoconductor target of the vidicon tube. During each sixth broadcast field, which corresponds to each single Apollo frame, the camera reads out one field of video signal at broadcast rates. During the next five broadcast fields, the camera's scanning beam is gated "off". The result is an interrupted video of one field "on", five fields "off".

The interrupted video signal—one field on, five off—then is fed to a magnetic disc recorder. The first field is recorded on the magnetic disc and read out five additional times to fill in the "off" fields. In effect, the recorder repeats the field five times to convert from interrupted to continuous broadcast video.

The magnetic disc recorder is similar in concept to "instant replay" devices used in sports telecasts. As soon as one broadcast field has been recorded, it passes a read-out head as a converted signal ready for commercial broadcast. The field is read out five times and a new field is then recorded.

Critical in the scan conversion process is the storage timing. The first storage comes when the incoming Apollo signal is taken from the display and stored on the photoconductor target of the vidicon camera tube to convert one field of Apollo scan rates to one field at broadcast scan rates. The second storage is on the magnetic disc recorder, which repeats each of the "on" broadcast fields five times to produce continuous broadcast video.

Scan converter performance, from pickup by an Apollo-rated camera, through the scan conversion process, to display on a broadcast quality monitor, produces a signal-to-noise ratio better than 35 dB, good gray scale fidelity, and a resolution response down less than 6 dB at 4 MC.

### RCA Countdown Computers

One computer, located within a mobile launcher,

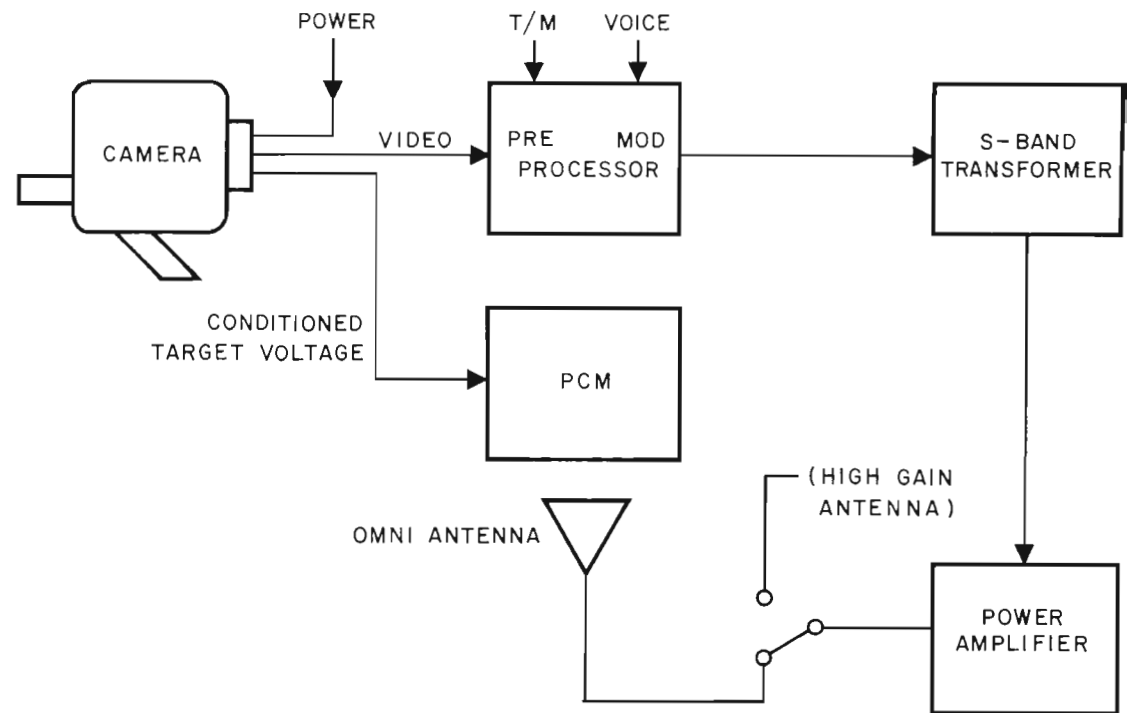
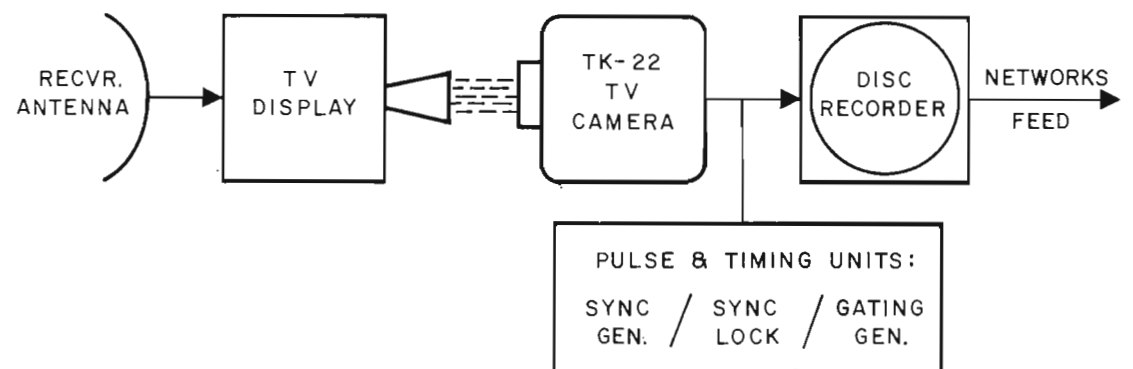

FIG. 4 Block diagram of the on-board Apollo television transmission system.

FIG. 5 Block diagram of Scan Converter system at ground stations in Florida, California and Spain.



checked out the Saturn V by commanding the rocket to exercise valves, engines, relays, and similar components then measuring the performance. A second RCA computer, located in the Launch Control Center, controlled the sequence of checkout and launch countdown programs performed by the first computer.

The two computers are joined by a digital data link that enables them to "talk" to each other. Should the mobile computer detect a problem, it is designed to inform its "twin" which will then initiate a search to pinpoint the trouble and to specify what corrective action must be taken.

The computers monitor 3000 parameters of the Saturn V. During the countdown, the information was displayed before the NASA mission directors—who could break in and direct the action manually at any time.

The computers used in the launch of Saturn V are part of 30 such systems developed by RCA for NASA.

### First Homeside Space TV

As millions of armchair viewers watched the Astronauts at work in the spacecraft and saw the fascinating shots of moon and earth, they helped usher in a new era of space exploration. Until now most television camera systems for spacecraft had been designed to obtain scientific data. The Apollo system had the additional privilege of initiating live and taped coverage for the world TV audience.

#### Operating Parameters of Apollo TV Camera

1. Bandwidth .....500 kHz
2. Frame rate/lines per frame .....10 frames per second/320 lines per frame
3. Output S/N .....36 dB typically
4. Camera Weight .....4.18 lbs. + lens (0.7 lb.)
5. Power Consumed .....5.3 Watts, 6.7 Watts max.
6. Imaging Tube .....1" vidicon, RCA 8134
7. Sensitivity .....0.1 ft.-candle highlight illumination minimum to 30 ft.-candles, maximum
8. Lenses .....(a) Wide Angle—160° 5.4mm f 2.0  
(b) 100mm, f 4.0 (T=9)
9. Controls .....(a) On-off switch located near hand hold  
(b) Automatic light control switch
10. Resolution .....250 TV lines limiting
11. Output Voltage .....2 Volts
12. Aspect Ratio .....4:3 horizontal to vertical
13. Gray Scale .....7 minimum
14. Input Voltage .....28 Volts nominal

# BIG JOHN BLANKETS CHICAGO FROM TEN-STATION TV ANTENNA ARRAY

When the John Hancock Building TV Antenna complex is completed this year, Chicago will become the site of the largest multiple antenna installation in this hemisphere and possibly in the world.

The antenna and supporting tower sections of five stations — WBBM-TV, WFLD-TV, WGN-TV, WMAQ-TV and WSNS-TV — will be mounted on two 12-foot diameter, 100-foot long masts on top the 100-story facility. Channels 5, 9 and 32 will occupy the West tower, and Channels 2 and 44 will be located on the East tower. Space is being reserved on triangular sections in each tower for the addition of still five more TV antennas sometime in the future.

Erection of the 140 tons of antennas and supporting structures atop the building to an overall height of 1,450 feet may eclipse the 16-year-old pioneer RCA system on Empire State Building as an engineering achievement. Installation of the John Hancock system is scheduled to begin this summer with operation by October.

## Multiple Antenna Systems Soar

The John Hancock installation adds to an ever growing list of multiple antenna systems. Since the birth of the five-antenna array on Empire State Building, RCA has designed and installed 15 vertically stacked systems and four arrays employing antennas side by side on platforms. Four more side by side combinations and a number of "stacks" are in the final stages of planning. Among these is an 11-antenna array for San Francisco, in preparation for which RCA is

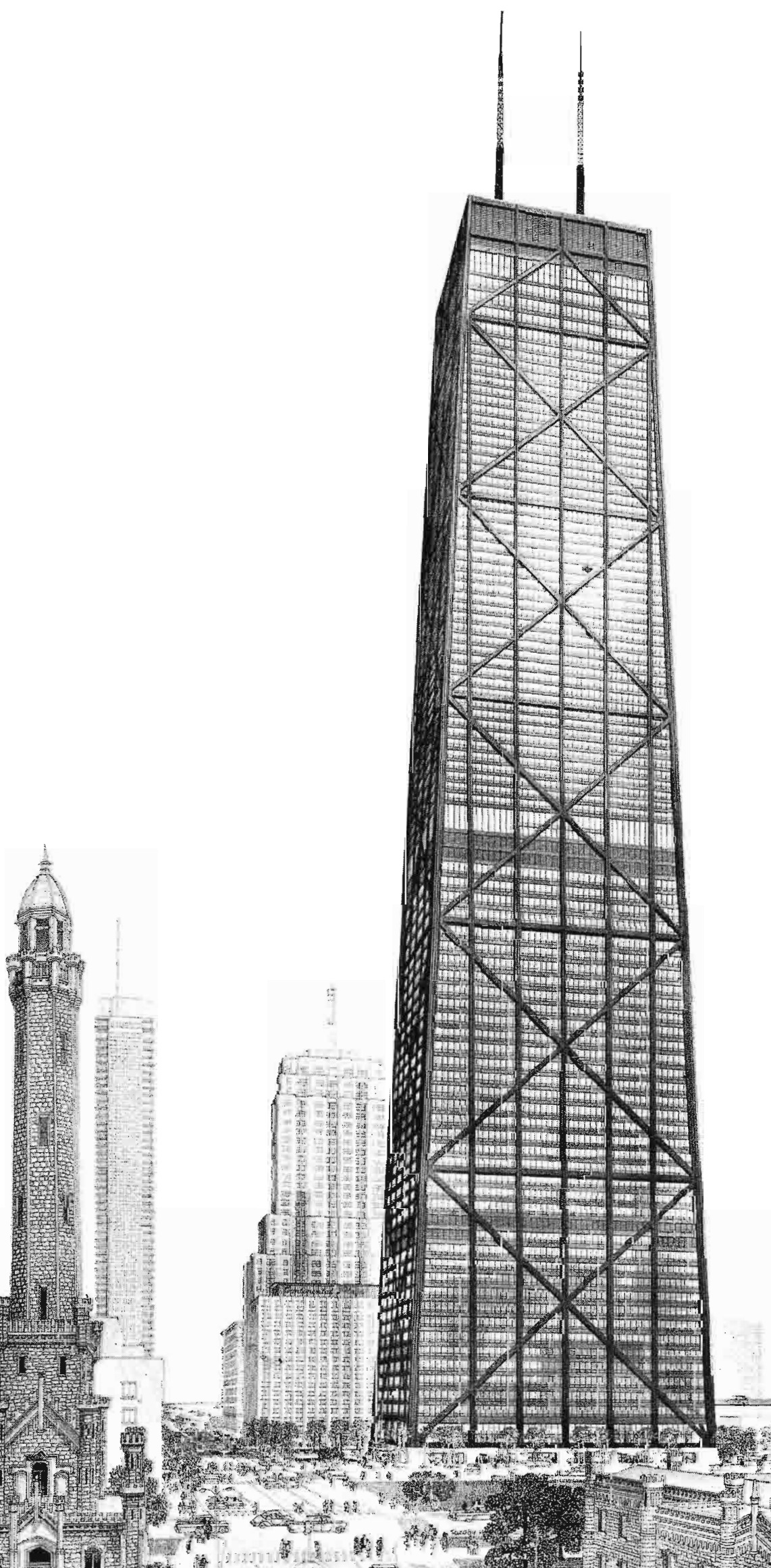

FIG. 1 When completed later this year, a sophisticated multiple TV antenna system on the new John Hancock Center will radiate the signals of five Chicago broadcasters from an elevation of 1450 feet. Eventually, ten stations will be accommodated.

FIG. 2 Scale model depicts twin tubular masts and tower sections supporting RCA Polygon, Butterfly, Zee Panel and Superturnstile TV antennas.

just completing a year and a half of mathematical analysis and operating scale model work.

There are many reasons why broadcasters are showing increased interest in tower sharing and multiple antenna sites. Of major importance to TV viewers, of course, is the opportunity for all receiving antennas to be oriented on the common transmitting point. Both the FCC and FAA strongly encourage pooling of site facilities, particularly in built-up areas, where land is scarce and air traffic heavy. The sharing of costs usually means savings in land, tower structures and erection as compared to a number of single antenna installations. There are advantages in the common use of power sources, roads and water supplies. By pooling manpower and maintenance equipment, one crew can service the entire installation.

### Wide Variety of Antennas Required

The stacking of antenna systems always involves important mechanical and electrical considerations which greatly influence antenna design. With each new installation, new requirements develop that can only be met with an expanding line of antennas having more flexible characteristics, higher power handling capability, greater strength, special shape or other qualities particularly suited to its needs.

In John Hancock, for example, with its potential of 10 antennas, the need for many transmission lines down through the antennas and supporting structures, and through the building to the transmitter rooms, affected strongly the choice of antennas. The

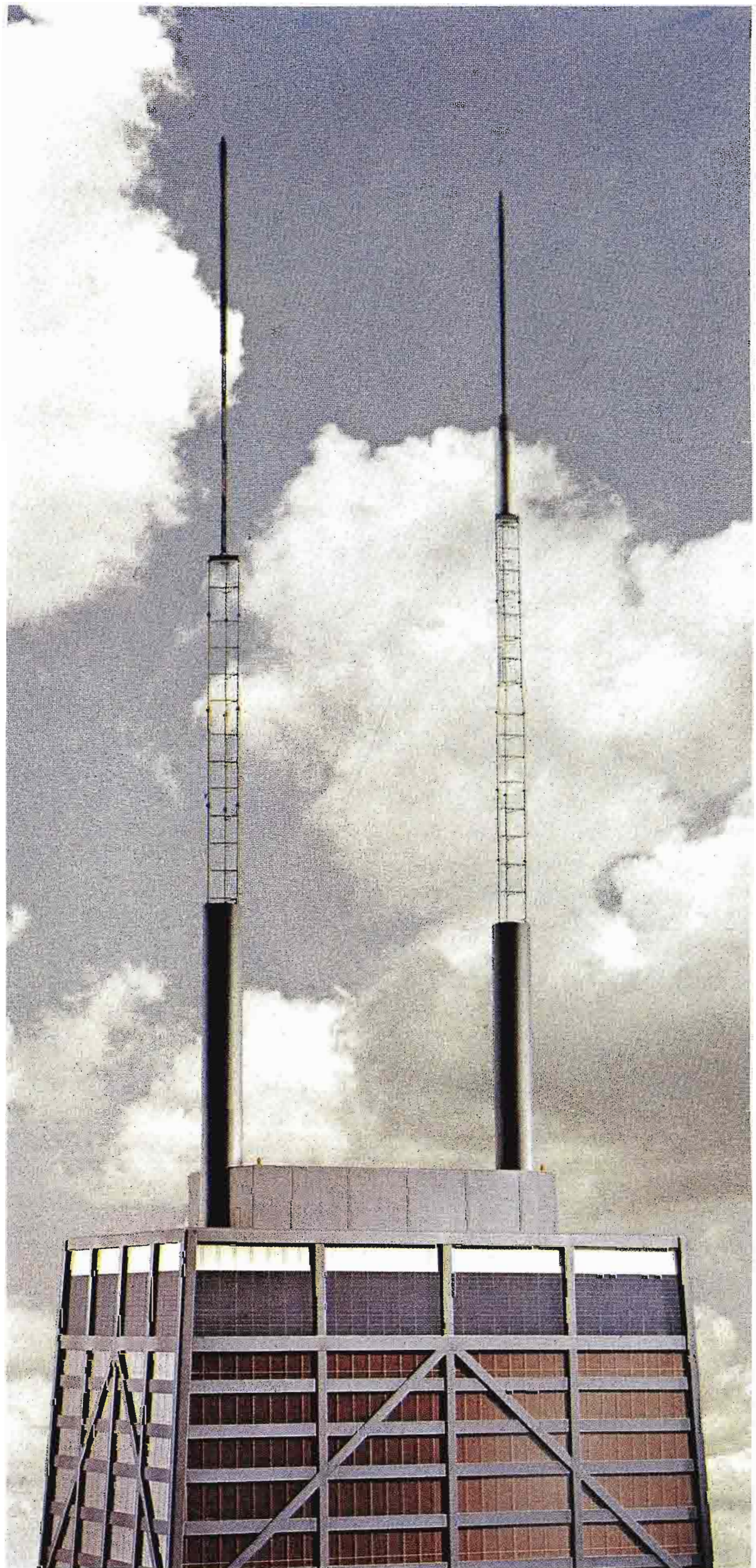

design of the antennas had to allow not only for the lines to come through, but also provide access to each line for test, repair or replacement. The strength needed in the 249-foot towers called for fairly large and rugged antennas which would provide the horizontal pattern characteristics of normally lighter and more slender antennas. Structural problems were further complicated by the requirement that the overall rigidity of each tower be such as to restrict sway of the top antenna to 0.5 degree with 50 mph wind. Holding the relatively narrow radiated beam of the top mounted UHF antennas within these limits avoids undesirable changes of signal strength at distant points.

Another important aspect in cases of systems where antennas are side by side is the effect that reflections and mutual coupling may have on the free space patterns of the individual antennas. This must be determined before a certain configuration can be deemed acceptable. The results of tests using scale models and the experience gained in the design and installation of similar arrays were invaluable in predicting the performance of the John Hancock system.

### John Hancock Antennas

Over the years, RCA has conceived and developed six different families of TV antennas—Superturnstile, Supergain, Pylon, Traveling Wave, Zee Panel Polygon, and Butterfly—each having from two to eight variations to meet special needs for gain, radiation pattern, power and mounting.

Having this variety from which to choose simplified the task of specifying antennas to meet the exact requirements of the five broadcasters sharing the John Hancock tower system, and of planning for practical answers for the possible five future TV facilities. Those selected and their specific applications were the Superturnstile (Ch.2), Butterfly (Ch.5), Zee Panel (Ch.9) and Polygon (Chs. 32 and 44).

The Superturnstile needs no introduction to broadcasters. The Zee Panel, an RCA development of the 1950's, employs one or more panels in various configurations to obtain desired patterns. Each panel comprises a center-fed zigzag shaped radiating element supported in front of a reflecting surface. The Polygon is a new, five-sided Zee Panel, and the Butterfly is a panel antenna employing Superturnstile radiators

FIG. 3 Topside view of 100-story John Hancock Center as it appears from the air. The twin, 100-foot steel bases for the TV towers stand out in this helicopter view of construction in December 1968. The view is to the Northwest.



FIG. 4 The John Hancock installation is the latest and most complex of a series of multiple antenna systems which began with the Empire State Building system in 1952. Today, there are 19 such systems produced by RCA and many more in the planning stages.

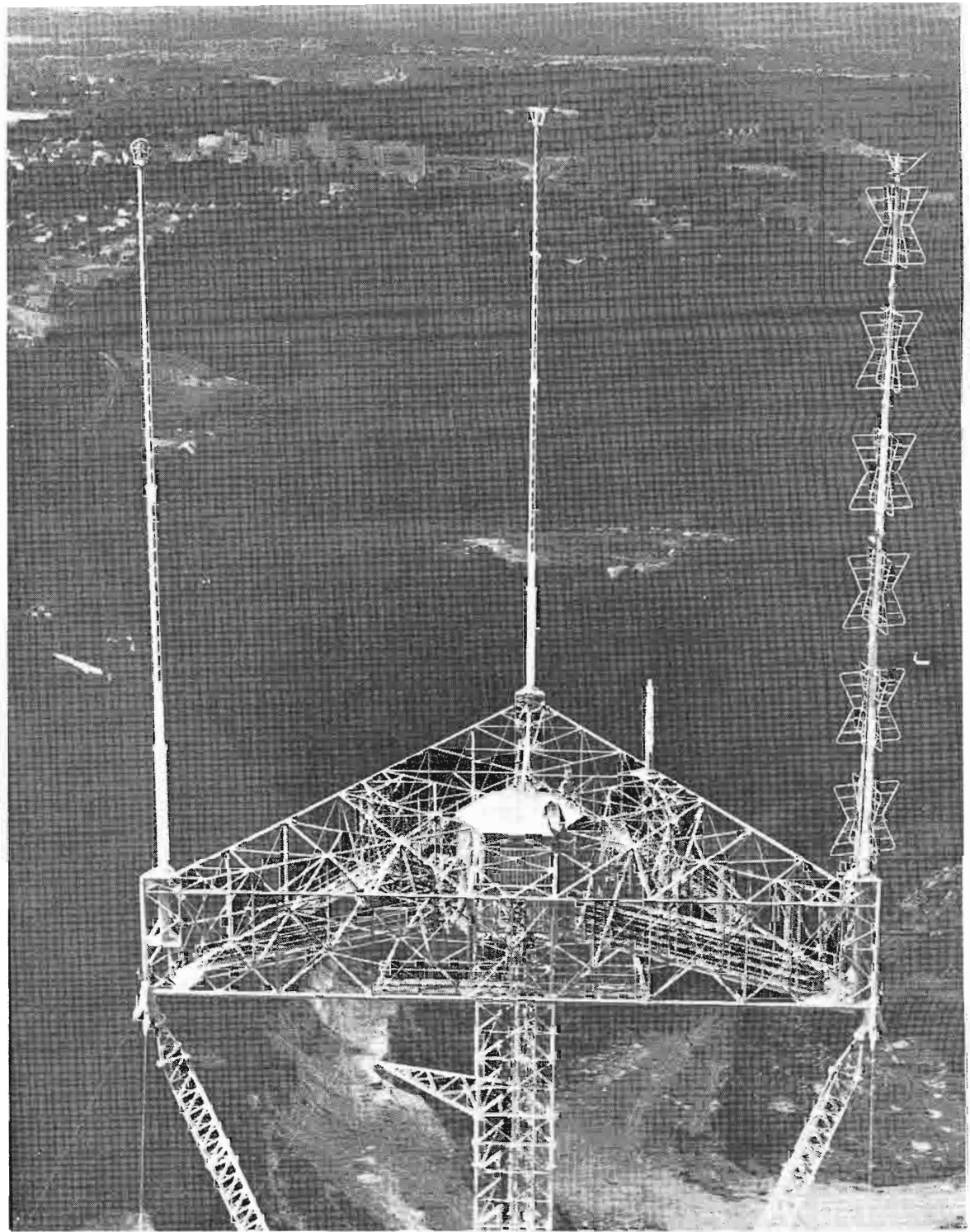

FIG. 5 World's first three-antenna "platform" built by RCA for WBAL, WJZ and WMAR, Baltimore.

in front of screens. The antenna expected to go on the array next, that of WCFL (Ch. 38), is the Vee Zee, a Zee Panel formed into the shape of a "V" along its central axis. The Vee Zee is particularly adapted to mounting on large triangular towers.

The arrangements of the antennas on the two towers are shown in Figure 2.

### Versatile Polygon

The UHF customers at the top of the towers specified patterns that would not only cover Chicago and north and south along the west shore of Lake Michigan, but would serve Gary, Indiana on the southeast shore as well. For this, the Polygon was ideally suited by virtue of its five faces, each separately controllable in magnitude of radiated signal. The cardioid pattern chosen illustrates the correspondence with the desired area of coverage.

Being directional, the UHF antennas could be made shorter. Thus, the lengths of these antennas at the tops of the towers are only 74 and 66 feet, compared with a 70 percent greater length for omni-directional antennas having the same gain.

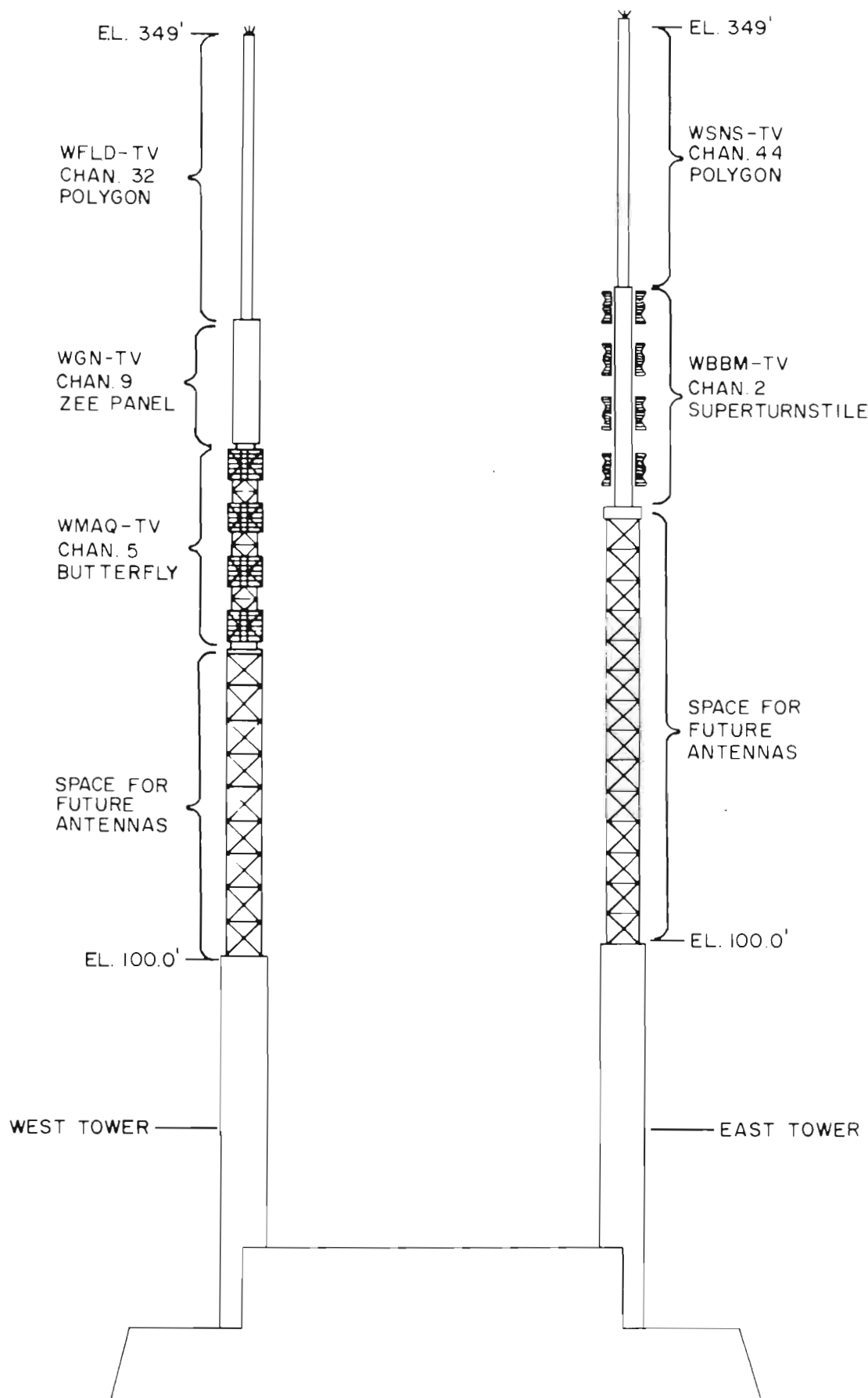

FIG. 6 Configuration of antennas mounted on twin East and West towers. Space is provided for five additional antennas.

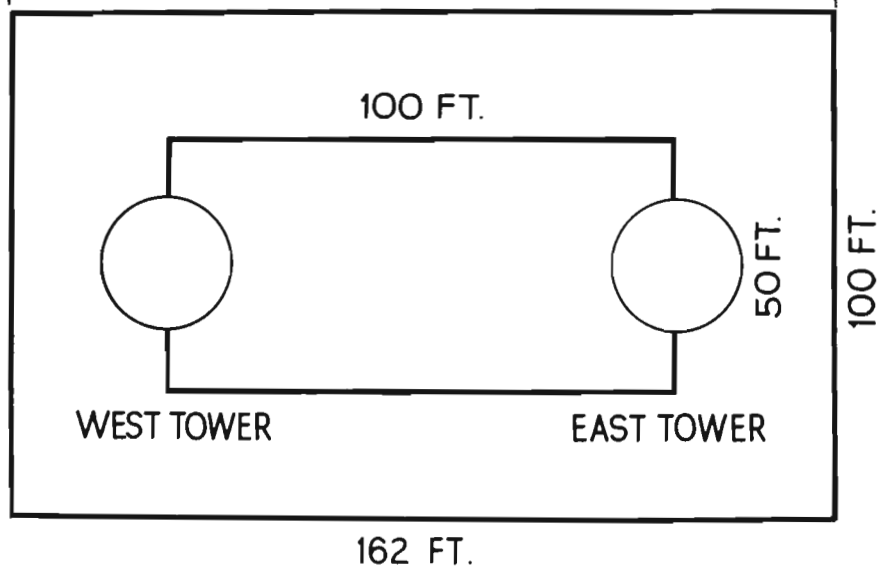

FIG. 7 Plan dimensions of top of John Hancock Center facility building and antenna towers.

Both will be capable of 5 megawatts Effective Radiated Power—the highest allowed by FCC for UHF stations, and both will handle 110 kW input power.

The Polygon has a wide range of applications. Beside great diversity of horizontal and vertical patterns, it is particularly adaptable to supporting other antenna structures in multi-antenna arrays. The walls of the five-sided steel sheath can be made as thick as desired, eliminating the usual space-demanding internal tower structure. Joining sections of the antenna are hoisted into position and bolted together. Individual elements in each five-panel layer are excited by an external belt line feed system and the several layers are connected and fed by a transmission line which is removable for servicing.

### “Butterfly” Panel

WMAQ-TV, Channel 5, will utilize the RCA 4-section Butterfly antenna with its familiar Superturnstile “batwings”. Like the Superturnstile, the Butterfly has excellent impedance, bandwidth and fine circularity even on large size towers. This antenna, being a panel type, can be arranged in triangular or square configurations and lends itself very well to horizontal pattern sculpturing for directional use. The design also presents a very small silhouette both physically and electrically, minimizing wind load and reducing pattern scalloping that might otherwise occur due to radiation from adjacent antennas.

### Zee Panel

Channel 9 (WGN-TV) will have a four sided RCA Zee Panel Antenna. As with the Polygon, radiation patterns of almost any shape can be achieved by varying the relative power input and phase to the panels. In this particular installation, however, the Zee Panel will be omnidirectional. Its long internal space permits maintenance personnel to work inside the supporting structure.

### Emergency Operation

All antennas except the Channel 9 Zee Panel, whose single panel makes it unfeasible, will be split-fed. That is, two separate transmission lines will be run to each antenna, one feeding the radiators above the center of the antenna and the other feeding the radiators below the center. This allows for emergency operation of either half of the antenna independently of the other in case of failure or while making repairs. The shift in mode of operation is made by coaxial switching in the transmitter room.

In addition to the emergency features described above, Channels 5 and 9 on the West tower will have separate auxiliary single layer Butterfly antennas at the top of the 100 foot supporting mast in the East tower. Channel 2 is currently planning to employ a similar antenna as its main auxiliary system and to mount it on the West tower.

The two supporting cylinders in the West and

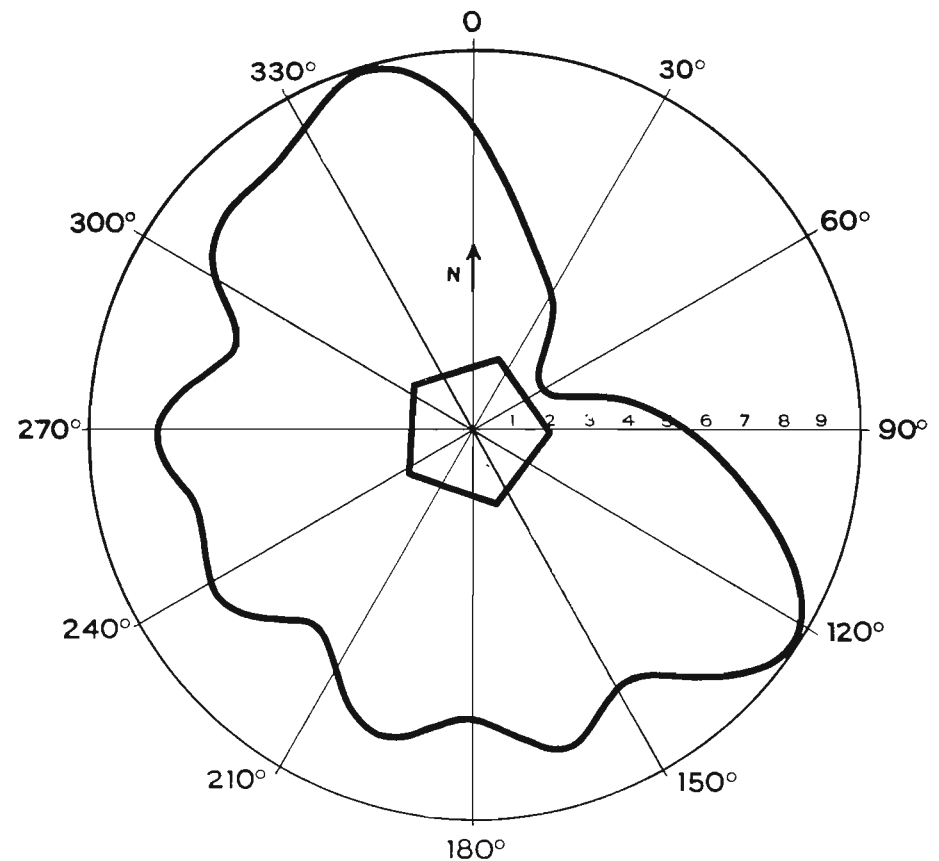
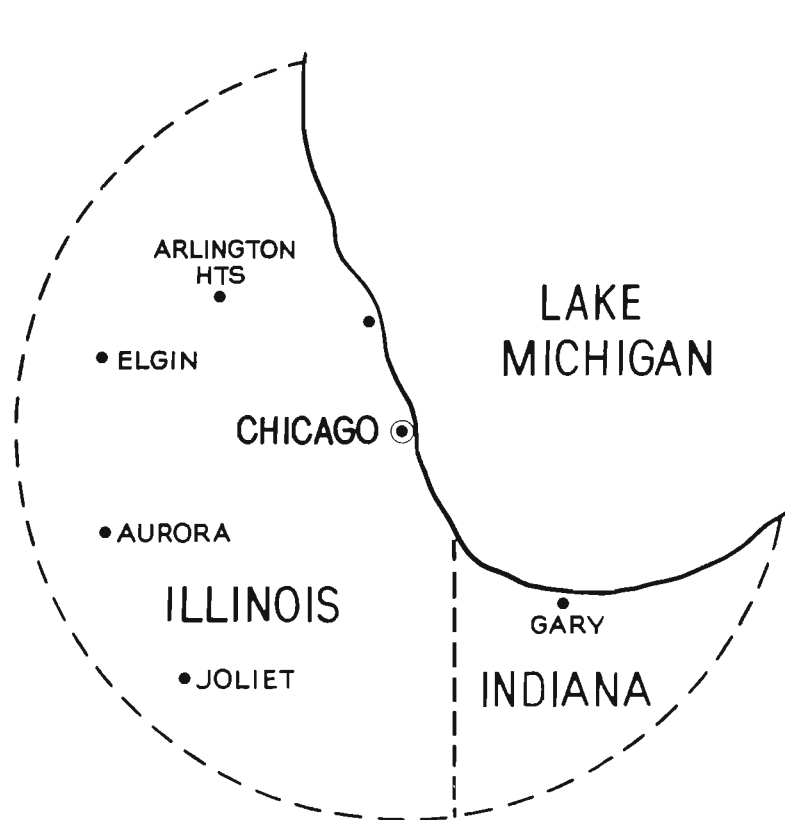

FIG. 8 Primary coverage area centered on Chicago is bisected by Lake Michigan. The horizontal radiation patterns of the UHF Polygons were tailored to meet this condition as shown.

East towers beside providing mounting space for the emergency antennas and point-to-point communications means will house all the transmission lines for present and future antennas, plus power feeds for beacons, de-icers, and working lights and outlets within the towers. A communication system connecting any antenna location with any transmitter room is also to be installed.

### Project Implementation

To coordinate the work of installation and test in Chicago, a Project Engineer has been appointed. An experienced RCA television engineer, he will provide cost control, on-site general supervision and coordination of contractor activities. To assist in this, he has set up a computerized project control system utilizing the Critical Path Method (CPM). Used by RCA in many large projects, this integrates the multitude of tasks, their proper sequence, and the various sources of manpower and equipment, to allow development of an efficient time schedule for meeting the on-air date. Initial output from the computer gives the earliest and latest starting times. Updating runs will show up potential delays and present timely action to be taken.

Certification of the final structural design is being provided by Edwards and Hjorth of New York City, mechanical consultants for RCA. Tower fabrication is by Dresser Crane and Hoist Company and erection at the site is by the Beasley Construction Corporation.

### Erection and Installation

The moving in of erection equipment will begin in May. After a staging area is fenced off on the street below the building, initial work of planking the roof, raising a temporary derrick and securing it to the

West cylinder will be accomplished. The temporary derrick will be used to raise a 30-ton derrick with a 100-foot boom. This will be set in place on the south side of the penthouse. Gin poles will then be erected on the East and West cylinders. Tower sections and antennas will be lifted from the street by the derrick and boom, transferred in the air to the gin poles, and stacked on the cylinders.

Chicago weather conditions make it necessary to complete the installation by early October.

### Proof of Performance

After all work is completed on the antenna structures, measurements and tests will be made by RCA to assure and demonstrate proper performance of the antenna complex. Tests and measurements will include determination of impedances and RF pulse values, DC pulse checks of the lines and decoupling between antennas.

### Chicago Broadcasters Antenna Committee

Specifications for the John Hancock TV system evolved during a two year study of the project by RCA and the Chicago Broadcasters Antenna Committee, with Dr. Frank Kear as Consulting Engineer. Members of the Committee, which were selected to represent Broadcasters who are to share the antenna site were:

William Kusack, Committee Chairman and Vice President-Chief Engineer, WFLD-TV; Ralph F. Batt, Vice President and General Manager, WGN-TV; Woodrow Crane, Chief Engineer, WGN-TV; Luther A. Pierce, Director of Technical Operations, WBBM-TV; Curt Pierce, Manager, Technical Operations, WMAQ-TV; Walter Lanterman, Transmitter Supervisor, WMAQ-TV; Yale Roe, Manager, WSNS-TV.



# ETV In Glasgow Teaches Teachers

W. G. BEATON, Director, Educational  
Television Service Corporation  
of Glasgow, Glasgow, Scotland



FIG. 1 Mr. W. Beaton, Director of Television, standing in front of main entrance.



*Glasgow is the largest City in Scotland. Due to a shortage of qualified teachers Glasgow has a particular teaching problem as far as the 300-odd schools and Further Education Colleges in the City are concerned. In an effort to meet this problem an ETV Service was proposed in January 1963 and following successful Closed Circuit Television demonstrations, the Service, as described in the attached article, was started in August 1965.*

*The Glasgow ETV Service is the first Educational Television Service of its kind in the United Kingdom and has been a guiding example to other education establishments and Universities when considering similar installations. Since the Service opened representatives from all over the world have visited the Studio Centre and observed the preparation and presentation of the educational "programmes".*

*Apart from being the largest Educational Closed Circuit Television Centre in the United Kingdom at the present time, the Corporation of Glasgow is the largest educational user of the RCA TR-4 Television Tape Recorders for, as can be seen from the enclosed photographs, they now have three of these machines. The TR-4's are well maintained by enthusiastic and competent engineers and they are giving excellent service.*

Glasgow Educational Television Service has the distinction of being the first closed-circuit system of its kind in Europe. It is a two-channel network, financed and operated by the local Education Authority at a cost of some £130,000 (\$312,000) per year. It opened in August 1965 with two clearly defined objectives: to complement the basic, day-to-day work of the schools with direct-teaching programmes deliberately geared in content and pacing to school syllabuses; and to provide a continuing in-service training of teachers in the rapidly changing content and methods of many curricular subjects.

Three major steps were taken to achieve these objectives. First, the selection of subjects, preparation of scripts and presentation of programmes were placed firmly in the hands of practising teachers, with the responsibility for co-ordinating this work and steering it through the technicalities of production resting squarely on the shoulders of the permanent ETV staff. In other words, Glasgow Educational Television Service is essentially a teacher-based structure—an ETV service for teachers by teachers.

Secondly, on the premise that local educational needs would best be served ETV-wise by a central

FIG. 2 Three RCA TR-4 Television Tape Recorders.



studio complex and a multi-channel distribution system covering every school and college in the city, an ETV Centre was built in down-town Glasgow and linked by a 100-mile underground cable network and 18 repeater stations to 325 primary and secondary schools and Further Education colleges. These were equipped with 27-inch receivers capable of taking both ETV and off-air signals.

Thirdly, since the flick of a switch on every school receiver would allow instant comparison of ETV programmes with the educational broadcasts of BBC and Independent Television, the targets set in terms of equipment and production were standards as near-professional as possible. It was felt that the ETV Service must be as competent in its small, half-acre as BBC and Independent Television are in their broad acres of television. No risk could be taken of having ETV programmes laughed off the screen by a captive school audience as the television equivalent of home movies.

As a result of these three measures, it can now be claimed with some degree of assurance that Glasgow ETV Service is no longer just one more interesting educational experiment but an accepted and acceptable part of the city's educational system.

Investment in the right quality of staff, equipment

and accommodation is paying handsome dividends. The Service began in 1965 with a staff of ten—a shade on the small side for the sizable job in hand. In October 1966, four additional posts were created to strengthen the clerical, engineering, graphics and studio teams. Then, to cope with the extra work involved in going over to two-channel operation in September 1967, four more posts were filled—an engineer, a graphics artist and two cameramen. In addition, two teachers were appointed as Mathematics Producer and French Producer respectively, bringing the total number of permanent staff up to twenty. The number of local teachers recruited on a part-time basis to write and present programmes is on the 35-40 mark. In the Glasgow context, this admixture of full-time and part-time personnel is proving very effective. The permanent staff provide the necessary continuity in administrative and executive matters; the practising teachers seconded on a part-time basis provide the running water, so to speak, which prevents the pool of ideas from becoming stagnant.

As much care was given to the selection of the right kind of accommodation and equipment as went into the recruitment of the right kind of staff. The ETV Centre, reconstructed from an existing Education Authority building at a cost of £80,000 (\$192,000),

FIG. 3 Typical class taking French programme.

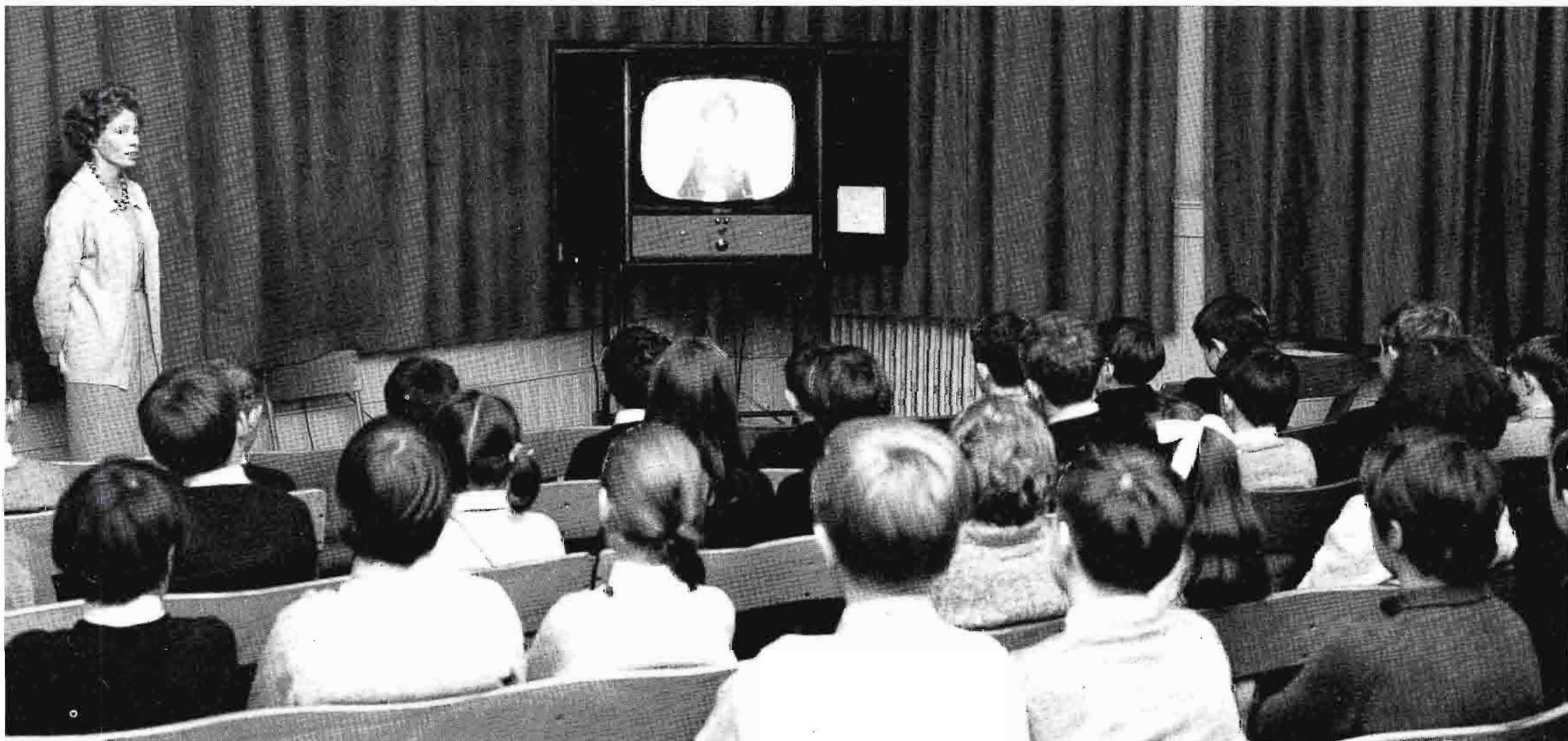



FIG. 4 Prof. David Sharpe giving lesson on wave theory.

is in the heart of the city and so is easily accessible to Glasgow's 7,000 teachers. On both the ground and first floors there is space for a 3-camera studio, 42 ft. long and 26 ft. broad, and a roomy control room. In the basement a central operations room houses a tape and film library, three RCA TR-4 video tape recorders, three telecine chains, equipment racks and a presentation desk custom-built to the specifications of the engineering staff. The graphics team—three in number—occupy most of the top floor and have staked a claim for all of it to house their rapidly growing collection of visuals. In addition to office accommodation for staff, room has also been found for a lounge and a library, each capable of seating 35-40 people and equipped with a monitor and off-air receiver. Both rooms are used almost daily by committees, panels and working parties of one kind or another. The end result is that the ETV Centre has come to have a local habitation and a name for hundreds of Glasgow teachers; the feeling has been created that the Centre, if it belongs to anybody, belongs to them!

The ETV Service got off the ground with three programmes per week on Modern Mathematics for secondary pupils and three per week on Oral French for primary pupils. Production was increased step by step

and now covers a much wider spectrum of the curriculum. In the current school year Channel 1 is transmitting to primary schools programmes in Oral French for six separate age groups, Science for senior pupils, and Health and Hygiene for infants' classes; Channel 2 is transmitting to secondary schools second and third form Modern Mathematics, fourth and sixth form Science, and a General Science series for first and second form pupils. In addition, the Service is networking five series of in-service teacher training courses produced in their own studio by nearby Jordanhill College of Education. It is estimated that the average number of programme transmissions in 1967-68 will total 50 per week on Channel 1 and 30 per week on Channel 2.

The hope in Glasgow is that one day the ETV Service will be in a position to make a really sizable and significant impact upon education in the city. That day has not yet arrived, however, nor will it come until there is sufficient equipment and staff to give full ETV coverage to all major aspects of the curriculum in both day schools and Further Education colleges. But there is general agreement that ETV staff can be permitted one small smirk of self-satisfaction at the progress achieved to date.

# 24-Hour Parts Service Helps Keep Stations On-Air

It's Sunday afternoon at the broadcast station . . . the main transmitter is losing power . . . with some quick action the transmitter engineer is able to stay on-air with the standby transmitter. But, unless he gets replacement parts fast, the station is in danger of going off-air any time. He remembers he can call RCA Parts and Accessories on Sunday. He calls the RCA emergency service number . . . the needed parts are on his desk before 9:00 A.M. Monday morning. In a short time the main transmitter is humming again and a grateful Chief Engineer heaves a sigh of relief.

## New Developments

RCA's Parts and Accessories Division is responsible for the supply of replacement parts for all commercial equipment produced by RCA. To help keep broadcast stations on-air, emergency service via a private direct telephone line, is available 24 hours a day, every day of the year. Some of the new developments

at RCA Parts and Accessories resulting in faster service to broadcast stations are: Completion of a \$1,500,000 addition to the RCA replacement parts depot in Deptford, N. J., in August 1968, which almost doubled the capacity of the existing plant, (Fig. 1). Two RCA 301 Computer Systems, (Fig. 2) installed at the depot. The shipping cycle for regular orders has been reduced from an average of 3.2 days in 1957 to a current average of 1.01 days. If necessary a helicopter can land at a heliport, situated a few yards from the loading platform in back of the Deptford warehouse to speed vitally-needed parts to Philadelphia International Airport. To serve our European customers better, a satellite replacement parts depot operated by RCA's Netherlands subsidiary, RCA N. V., has been established in Amsterdam, Holland. Amsterdam was chosen because of its central location, good customs service and excellent transportation facilities.

FIG. 1 Largest broadcast parts depot in the world, located on a 132-acre tract in Deptford, N. J., where RCA operates a complete, modern distribution center, covering 350,000 square feet.

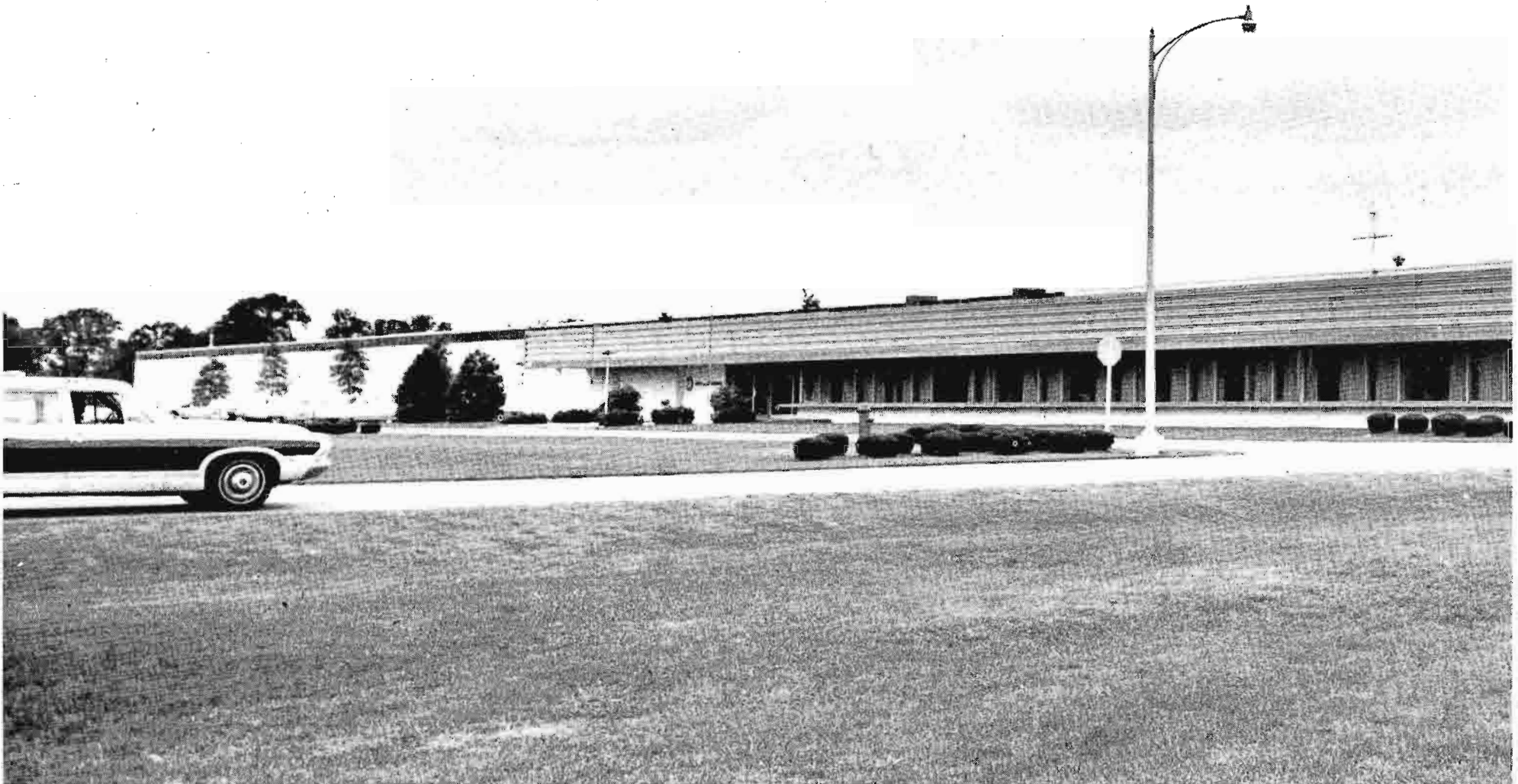
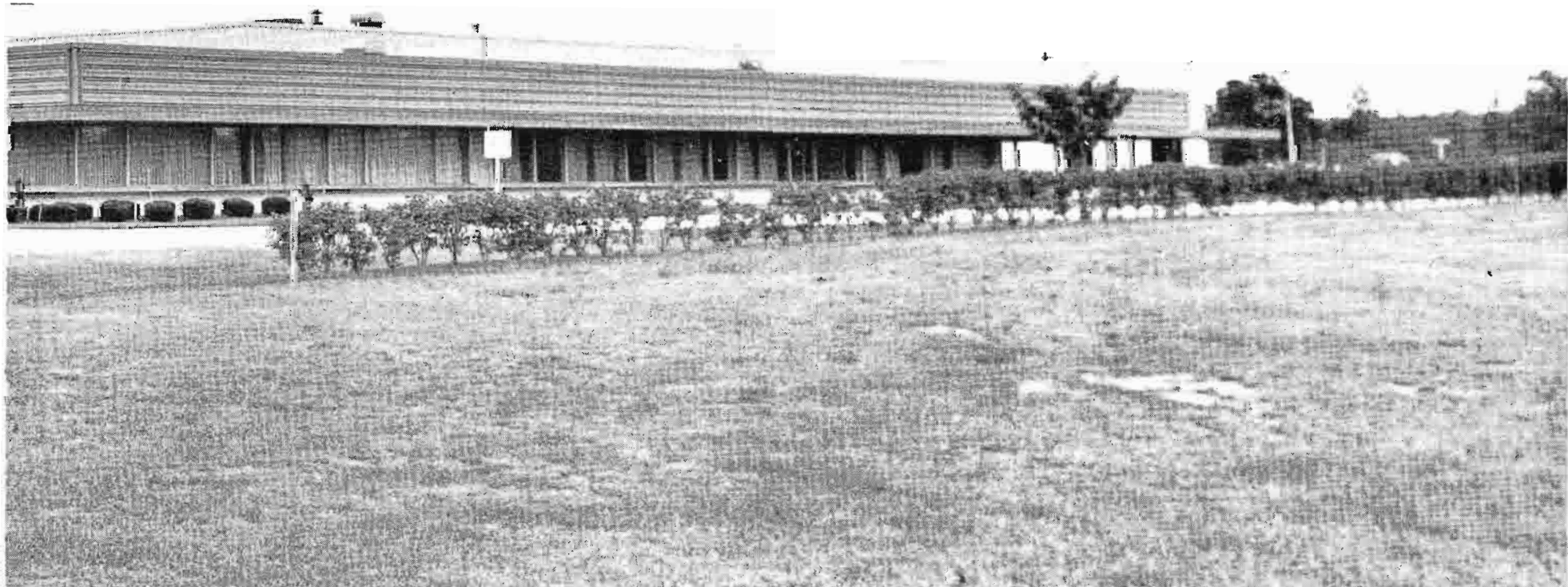



FIG. 2 Two RCA 301 Computer Systems give answers to complex requirements in minutes that would otherwise take months. This highly sophisticated computer system writes at 1200 lines per minute to maintain parts inventories.



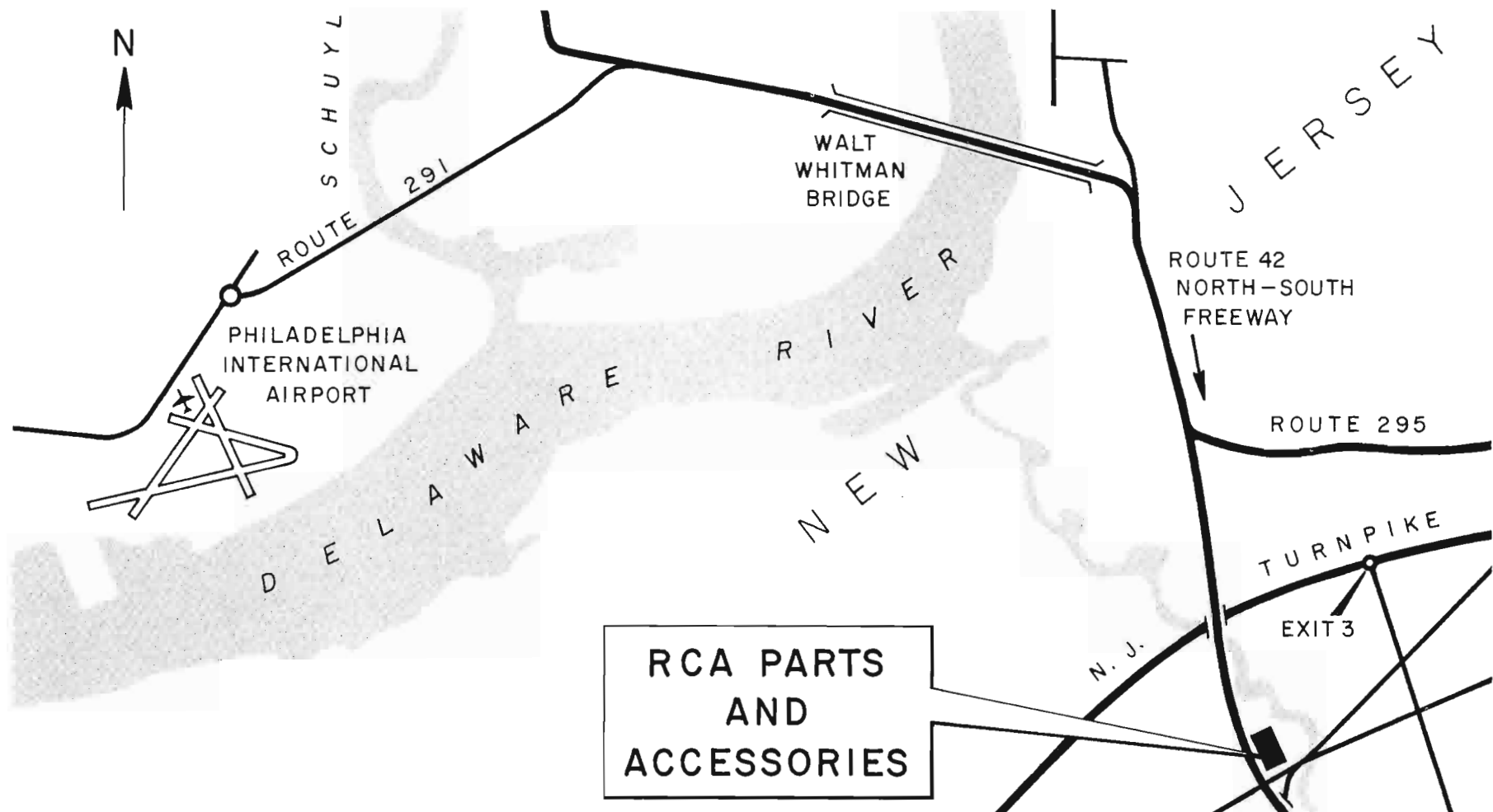

FIG. 3 RCA Parts and Accessories is within minutes of the Philadelphia International Airport, interstate highway systems, coast-to-coast railroad networks and one of the nation's largest ocean ports.

### Huge Facility

The RCA Parts and Accessories function occupies a complete, modern distribution center employing over 400 people. It was only three years ago when the division moved from Camden to a new 200,000 square foot plant. The recently completed construction added 150,000 square feet of warehouse space, bringing the total building space to 350,000 square feet. It is the largest commercial electronic parts depot in the world. Seven football fields would fit in the buildings with room left over. The operation is situated on a 132 acre tract of land, owned by RCA, in Deptford, N. J. in the Philadelphia/Camden metropolitan area. From the Deptford warehouse, electronic parts are shipped daily to destinations all over the world by truck, rail, ship and plane. The post office and other carriers make regular scheduled pickups at the Deptford depot. Fig. 3 shows the convenient location to highways, airports and port facilities, providing easy access to the quickest and most economical shipping services.

### Extensive Stock

Today, the RCA Parts and Accessories line encompasses 19,000,000 different parts of which 3,023,000 parts are related to the broadcast industry. Shelf quantities average 150 units per part. All the replacement parts are stored in numerical sequence in row after row of bins to expedite the location and shipment of customer orders, (Fig. 5). This extensive stock protects virtually all RCA commercial equipment now in use. The inventory value of the stock is over \$13,000,000 of which \$400,000 worth are relatively inactive items (protection inventory), kept on the shelves to

protect RCA equipment in customers installations. The policy at RCA is to supply replacement parts for broadcast equipment for at least 15 years, however, some of the parts in stock are over 25 years old, (Fig. 4). The credo at RCA is, "as long as a piece of gear is in the field we keep the parts".

### Computerized Processing

Inventory control is rigidly maintained by a highly sophisticated RCA computer system which reviews recommended quantities to be purchased and inventory levels to be maintained for each part. Inventories are up-dated daily and new forecasts are computed every week. The current out-of-stock position is less than  $\frac{1}{2}$  of 1% of the total number of parts.

In addition to inventory controls, the computers, writing speeds of 1200 lines per minute, produce such pertinent and timely output as: prices, sales history, shipping information, current purchasing history, open purchase orders, follow-up reports and literally hundreds of other reports necessary for running such a complex business. While the computers control thousands of individual statistics, they are programmed to issue reports only on those items requiring action.

Customers questions can be answered and orders can be followed-up swiftly by "punching-up" the customers computer control number. The computer memory stores all information relating to customers orders to aid in fast order processing. The ordering data is key punched directly to magnetic tape. The present cycle of a regular parts order from receipt to shipment is 1.01 days.

In the future the computer will perform many



FIG. 4 The modern fork lift creates an interesting contrast to some broadcast transmitter parts in stock over 25 years.

FIG. 5 All the replacement parts are stored in many aisles of bins, row after row, to expedite the shipment of customer orders. Motorized carts are used to get around the huge warehouse.



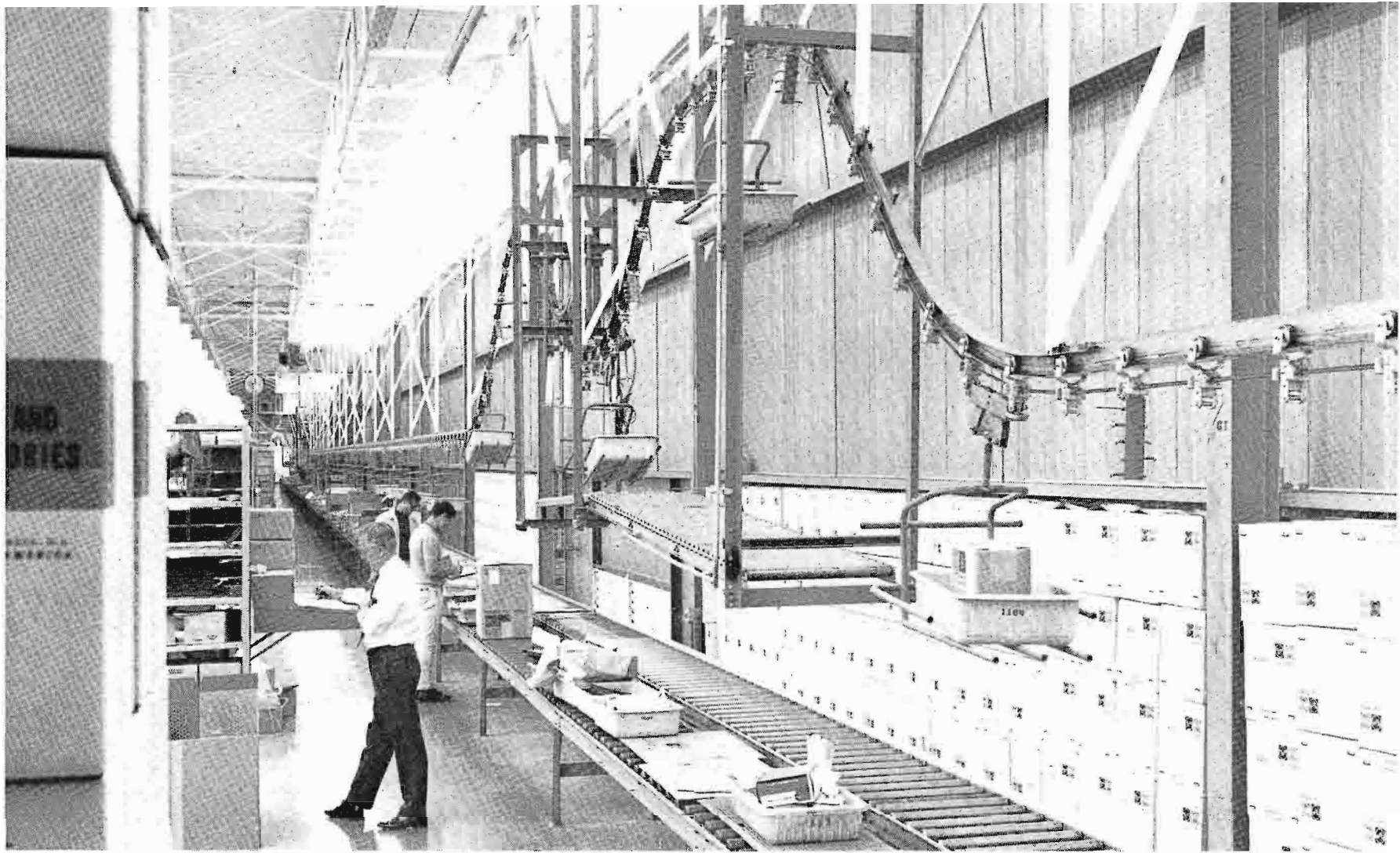

FIG. 6 Almost a mile of conveyor system handles orders. A separate overhead express conveyor delivers orders automatically to the shipping section.

FIG. 7 Emergency service orders are taken here by specially trained personnel. Customer inquiries and adjustments are also handled in this area by phone, in writing, and by TWX.



EMERGENCY  
ORDER  
SERVICE  
FOR  
BROADCAST  
STATIONS

(a) Emergency service man receives the cable . . .

(b) quickly cross-references the parts . . .

(c) rides a motorized cart to parts location . . .





new functions. Perhaps, someday a customer's computer will communicate directly with RCA's computer eliminating possible human error.

### Write, Telephone or Telegraph

Customers may communicate directly to the customer service area, (Fig. 7). Regular orders can be given by calling telephone number 609-848-5052 and asking for "Pat Allen". The "Emergency Service" telephone number 609-848-5900 is a private direct line eliminating the need to go through a switchboard. Stations having TWX facilities can send telegraphs directly to the Parts and Accessories TWX number, 510-686-8982. RCA emergency service personnel are on hand to answer emergency service telephone calls and TWX's at the Deptford, New Jersey office 24 hours a day, 7 days a week . . . every day in the year.

An emergency service order puts a special system into gear where every facility is put into immediate action to speed shipment of the parts. The orders are individually hand carried through the system by the specially trained man answering the call. If a part is not in stock the emergency service man calls the RCA department that makes the part to have it shipped directly to the customer.

Emergency shipments are normally taken to Philadelphia International Airport by ground transportation, as it is only a 15 minute drive, but when conditions warrant they can be loaded on a helicopter at a heliport in back of the Deptford warehouse. At the customers request RCA will supply the name of the carrier, waybill number, flight information, time of arrival, etc. The series of photos in Fig. 7 relates the step-by-step handling of an emergency order from a broadcast station.

### Quality Parts and Service

Every department at RCA Parts and Accessories has a vital role in safeguarding replacement parts quality. A quality control section surveys parts coming in, parts in stock and parts going out to be sure they will give the same high quality performance originally engineered into RCA equipment.

The cataloging department keeps ordering infor-

mation accurate. All parts used in commercial products produced by RCA are carefully reviewed with marketing and engineering staffs of RCA product divisions and decisions are made on parts required for replacement stock. Up-to-the-minute information on changes made to equipment is recorded so that catalog information is accurate and current. Parts identification service is available for customers who have difficulty identifying parts or need parts that have not been cataloged.

Almost a mile of conveyor system handles orders promptly. Parts are drawn from stock as the order moves along the conveyor, (Fig. 8). A separate express conveyor delivers the completed orders automatically to the parcel post section for packing, weighing and postage. The paperwork is returned to the computer using a pneumatic "air-tube" system. It automatically routes to any of 8 different stations delivering drawings, paperwork and small parts. RCA Parts and Accessories is organized to offer the best replacement parts service in the world to protect the customers investment in RCA broadcast equipment.

### TO ORDER RCA REPLACEMENT PARTS

#### REGULAR ORDERS

**MAIL TO:**  
RCA Parts and Accessories  
P. O. Box 100  
Deptford, New Jersey 08096

**TELEPHONE:**  
"Pat Allen" 609-848-5052  
Customer Service 609-963-8000  
Extensions PT-641, PT-674, PT-675

**TELEGRAPH:**  
TWX: 510-686-8982  
Western Union  
Cable Address: "RADIOPARTS"

#### EMERGENCY ORDERS

**TELEPHONE:**  
609-848-5900 (any day or time)

**TELEGRAPH:**  
TWX: 510-686-8982  
Western Union  
Cable Address: "RADIOPARTS"  
(Be sure to request "EMERGENCY SERVICE"  
if desired)

(d) finds the parts . . .



(e) packs and weighs parts for shipment . . .



(f) calls for helicopter or special carrier.



FIG. 1 Cutaway of miter elbow showing method of inner conductor support.

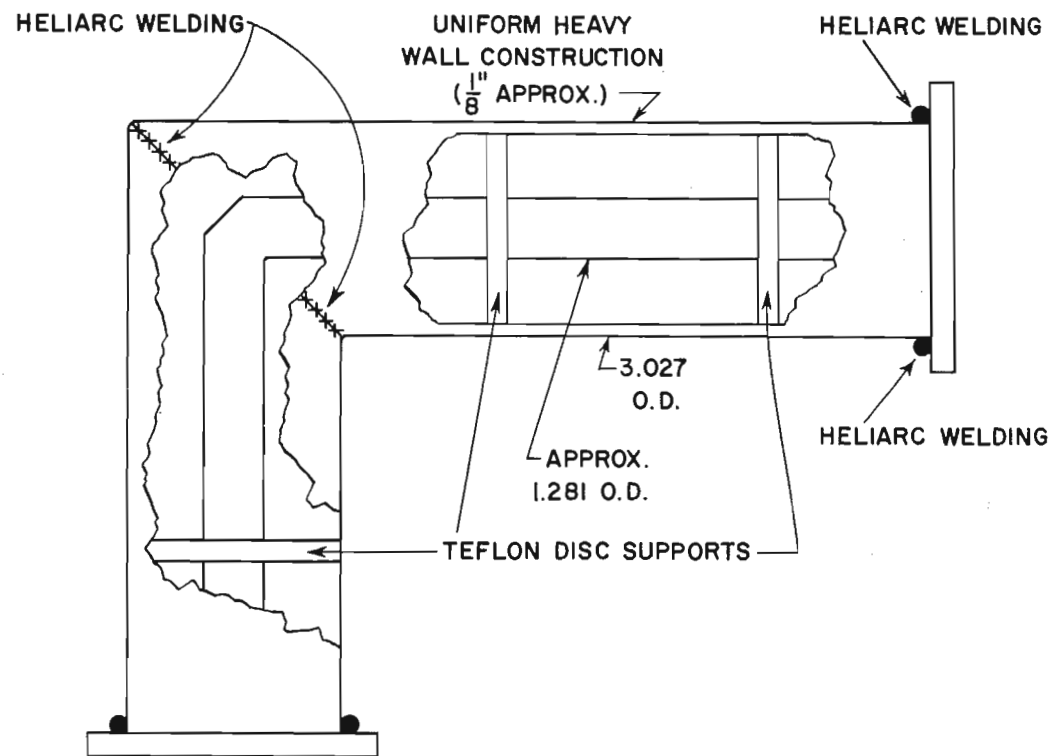

# RCA Transmission Line . . . The Inside Story

There are important quality differences in various makes of transmission line. Sometimes, however, the superiority of one line over another is not obvious until after a period of service during which one has failed. Experience and service, therefore, contribute to the supplier's knowledge of what should go into a reliable transmission line. Following are some important considerations in selecting a design.

## Beware of "Cost Saving" Line

Transmission line is one item no supplier can over-design. The cost of a single failure—in prime time or any time at the top of that 1,000 foot tower—completely wipes out any saving a supplier has passed on to the customer by cutting corners in design. But what you and I sometimes forget are the many factors that can affect the performance and life of transmission line and how to go about meeting them. It takes long in-service periods, experience, and lots of field investigations and reports. But ultimately the improved line, though it may add up to money, represents a very worthwhile investment for the broadcaster. It may also result in a transmission line that is fundamentally different from other types offered the broadcast industry, because it incorporates the modifications and improvements that come from continued attempts to eliminate possible failures.

## Heliarc Welding

RCA heliarc welding of outer conductors, as an example, resulted from repeated failures of silver soldered line. The silver soldered joint is tight at the factory but, unavoidably, there is flux imbedded in it and through stress and flexing in the field, the flux breaks down and allows gas leaks to develop. Another problem with silver soldering is the tremendous heat needed. It spreads over large areas, tending to anneal or soften the line near the flanges, and making them

vulnerable to dents and other distortions at installation. Heliarc welding, on the other hand, requires no flux and confines heat to a very small area. It also prevents the brazing material from running under the flange to the inside surface of the outer conductor. This may happen with silver solder, requiring extra steps in finishing the inner surface.

## Stronger and More Reliable Elbows

In addition to the heliarc welding of flanges and miters, elbows are fabricated of uniform thick-wall ( $\frac{1}{8}$  inch) copper. This eliminates the need for external silver-soldered reinforcing shells. The need for strong leak-proof elbows is particularly important where you find the most serious stresses, such as at the bottom of long vertical runs of transmission line.

Another advantage is the extra support given the inner conductor in RCA elbows. The long leg uses two captive insulators and the short leg uses one. This configuration results in mechanical stability and requires the least skill in installation. Mechanical stability, of course, results in long term electrical stability. In some competitive "els" the inner conductor is simply supported at the ends of the arms by the anchor insulator. Unless great care is exercised in assembly, there is risk of producing a bad connection, one that could cause mismatch or voltage breakdown.

## Inner Conductor Support

Consideration should also be given to design for best inner conductor alignment and support. At the present time disc insulators, rather than the pin or rod types, are used. The disc, although more expensive, is more stable mechanically and gives better long term service especially in wind and vibration. Contrasted to the pins, the discs are also electrically compensated by the undercuts on the inner conductor. Construction is shown in Fig. 1.

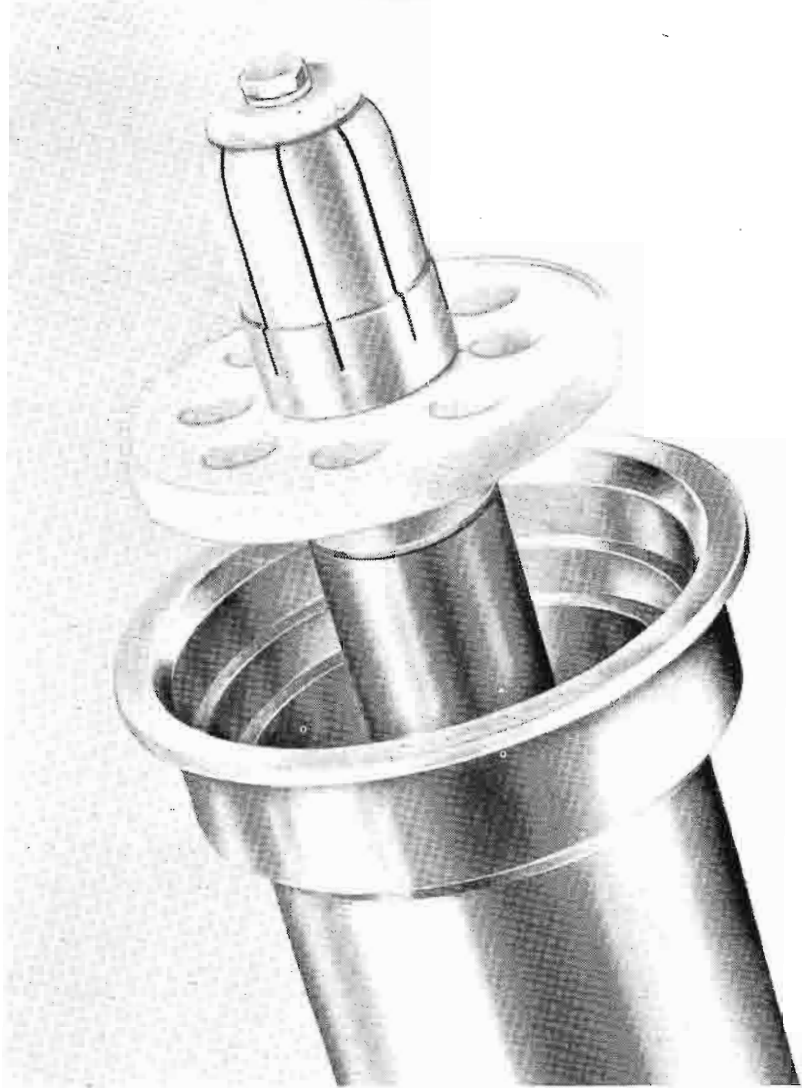

### Split Proof Bullets

Too much emphasis cannot be put on any design that makes installation easier or more foolproof. One such feature is the disc that surrounds the inner conductor fingers of RCA line. This is illustrated in Fig. 2. It is a brass sleeve insert carrying a protective ring that prevents any possibility of finger damage through misalignment of sections that are being joined.

### "Wristband Expansion Joint"

This unique expansion joint, diagrammed in Fig. 3, was developed to prevent galling of the inner conductor connector as a result of thermal expansion and contraction of the line. Galling action produces grooves in the connector which gradually widen to form a resistance joint. Also, the metal chips often fall upon the insulator, and in time there is sufficient accumulation to cause flashovers.

The wristband joint is a "dry" joint requiring no lubrication whatsoever. This is mentioned because expansion joints with baked-on lubricants were tested and a tendency for the lubricant to dry out was discovered. When this happens, galling begins. The wristband, to the contrary, uses a silver-plated beryllium copper spring that connects the inner surface of the tubing to the outer surface of the connector assembly. Because of the hard surface and the many contact points around the diameter of the wristband, the joint offers excellent conductivity at any point in its travel with a minimum of galling. Moreover, any metal particles that may result are completely and harmlessly locked inside the inner conductor.

### The Universal Line

This Teflon insulated, flanged line has proved to be the most versatile and successful of all the types of line. It has the extra dependability needed for the taller towers and the ease of assembly required by to-

FIG. 3 Universal line coupling in cross-section. The "sexed" coupling prevents misalignment during installation and the fully-captive "O-ring" gasket assures a leakproof joint.

FIG. 2 Universal line with inner conductor pulled out. Teflon anchor normally fits against smallest shoulder on inside of flange. Brass protective disc over ends of fingers prevents splitting of bullets by misalignment.

day's speedier tower erection methods. As of this date, more than 275,000 lineal feet of Universal transmission line has been installed in 200 broadcast systems and not one electrical failure has occurred as a result of galling.

Universal line has a unique "goof-proof" coupling. There are no flange bolts. Instead, a single, stainless steel bolt clamp of the "Marman" type completely surrounds the beveled edges of mated male and female flanges as shown in Fig. 3. The design is such that the clamp fits only when the two flanges are fully mated, preventing inadvertent misalignment during installation. A captive O-ring allows the rigger the best advantage in assembling lines. He does not have to touch the O-ring at all. It is held captive in a groove on the male flange, and there is no chance of the O-ring being squeezed between the flange surfaces to cause a leaky joint. All joints swivel, making it unnecessary to match the position of other line sections when installing a line section. Flanges are heliarc welded, and the line incorporates the wristband expansion anchor insulators and split-proof bullet features previously described.

### Conclusion

Transmission line is a field where considerable experience is required, not only in design and fabrication of hardware, but in installation and servicing of systems as well. The many improvements that have been incorporated over the years make today's line a totally new and different approach, free of past limitations and offering the highest standards of performance and reliability.

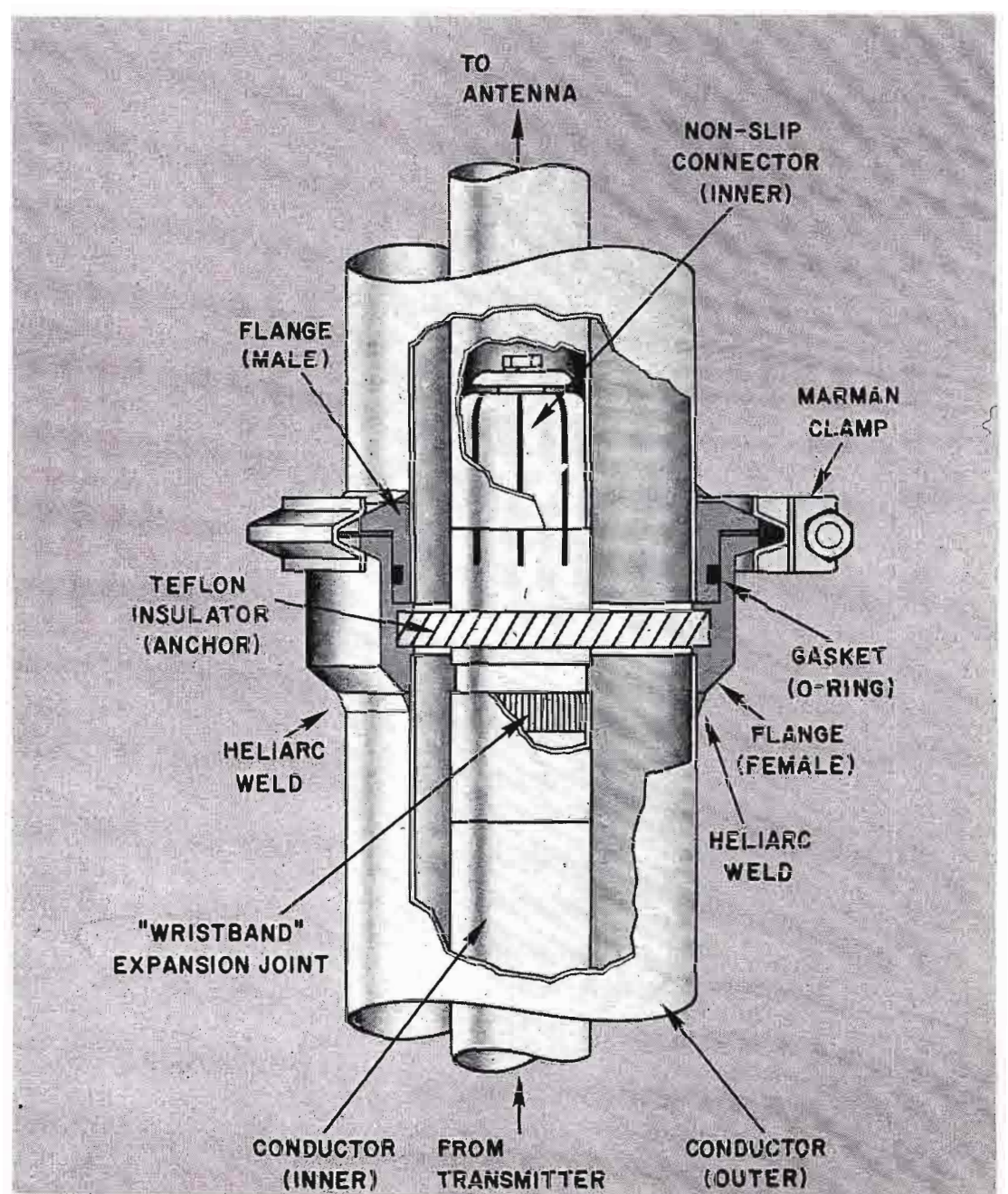

# RADIO TÉLÉVISION NATIONALE CONGOLAISE

New TV Station Debuts  
In Central Africa

DENIS MANGENDA, Chief Engineer

FIG. 1 Chief Engineer Denis Mangenda at switching console.

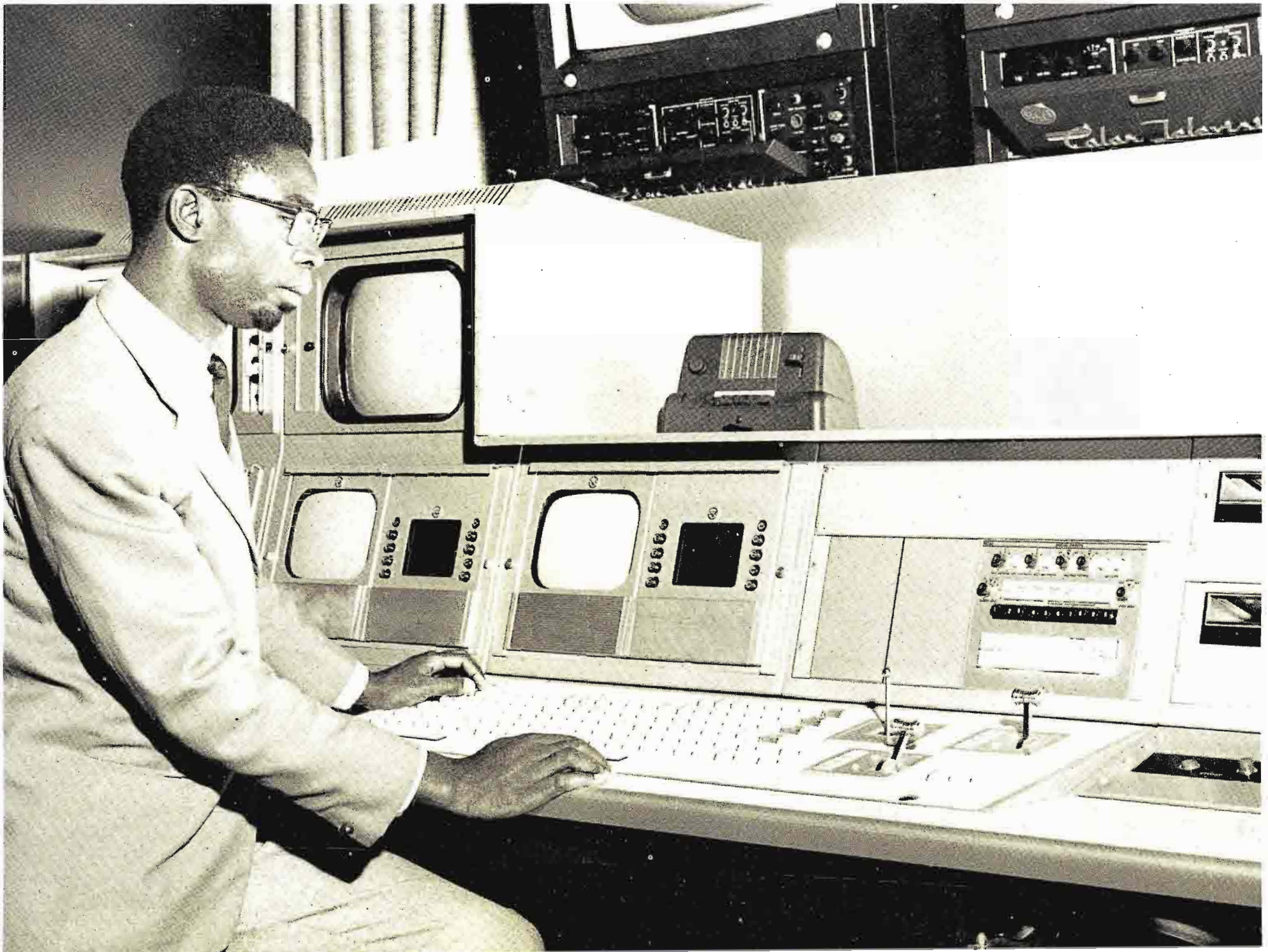

FIG. 2 Mobile unit, decorated in the national colors, transports cameras and tape recorder equipment to remote locations for telecasts of sports.

L'ingénieur Denis Mangenda décrit comment le Gouvernement congolais a fait ses débuts dans le monde de la TV le 23 novembre 1966 en diffusant, par des antennes d'émission installées dans les hauteurs qui dominent Kinshasa, Brazzaville et Matadi, des images provenant de sa première station de prise de vues en direct.

Les émissions de la station gouvernementale Radio Télévision Nationale Congolaise, exploitée par le Ministère des Informations, comprennent les actualités nationales et internationales filmées et transmises sur le réseau national de télévision, des communiqués de l'Agence Congolaise de Presse, des interviews en studio et des reportages sportifs pris sur place. Des émissions publicitaires sont également diffusées. On prévoit pour l'avenir des émissions scolaires à destination de téléviseurs placés dans les écoles, les hôpitaux et les places municipales.

Les studios de télévision et l'équipement émetteur sont installés dans une villa adaptée à ce but et non loin des studios de radiodiffusion. Les installations comportent un studio à trois caméras, des systèmes de télécinéma et d'enregistrement et reproduction sur bande, et un émetteur de 500 watts. Dans un proche avenir, un relais hertzien sur microondes transmettra l'image de TV du studio vers un nouvel émetteur plus puissant situé à Binza.

Le succès de la nouvelle station, érigée en moins de quatre mois, est attribué en grande partie par l'auteur à l'excellente collaboration entre le personnel de la station et P. C. Berben, ingénieur de ventes de la RCA, ainsi qu'au travail assidu de l'équipe qui a procédé à l'installation.

When the Congolese Government decided suddenly to have its first live pickup TV station on the air by November 23, 1966—one day before the anniversary date of President J. D. Mobutu coming to power—we had to move fast since it was already July.

Several well known manufacturers were contacted but only RCA promised to meet the very short delivery period. They also proposed to loan us cameras.

On November 1, RCA moved in with the cameras, film island, a portable studio lighting kit, transmitter and microphones—in a word, the equipment we needed to have a picture on the air, and one that remained on the air for six months awaiting arrival and installation of the final equipment. It was indeed a "mini station", but we can now look back upon a fault free initial period. Meanwhile, we have purchased the borrowed cameras and they will be installed in our training school.

### Plan Power Increase

Our present TTL-500H1 transmitter is installed within the studio grounds but a TT-12EH 10 kW transmitter is being constructed at our Binza transmitter site, high on a hill, overlooking the towns of Kinshasa and Brazzaville. A TVM-6 microwave link will relay the signals over the ten-mile hop from our downtown studio facilities to the new transmitter site where they will be broadcast by a highly directional, VHF highband antenna system.

FIG. 3 A quartz-lighted, 3-camera studio originates newscasts and personality interviews.

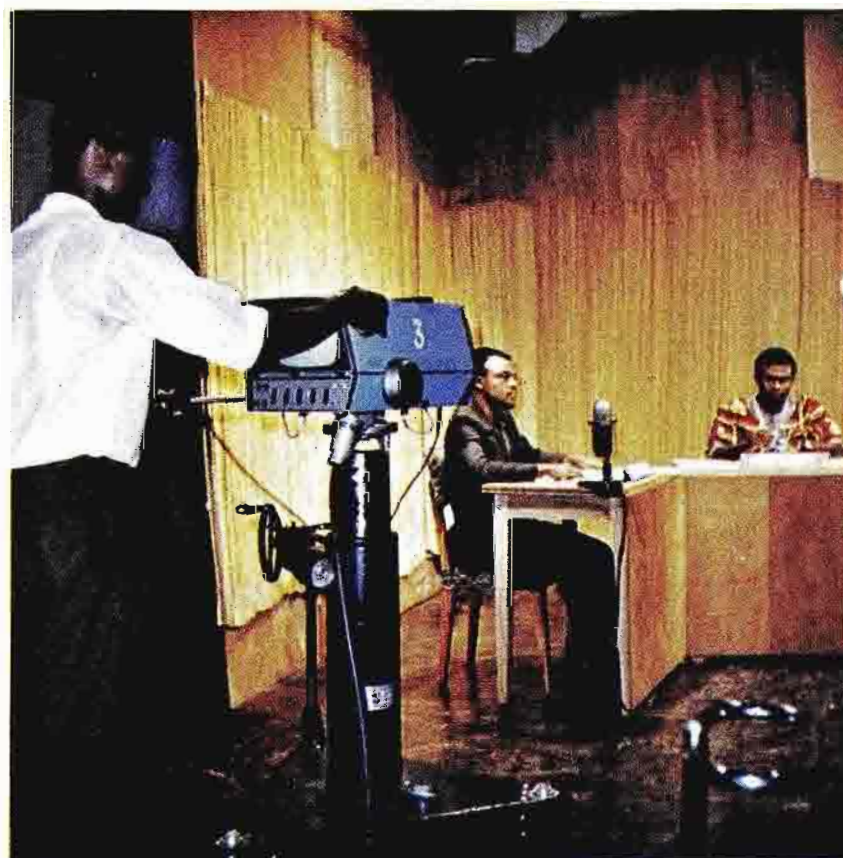

We now have a circular pattern with a 15-mile radius, covering a population of approximately two million. Coverage with the new transmitter will be much better. By increasing power and directing our signals toward Matadi, we will reach more of the remote areas. There are roughly 10,000 TV receivers in Kinshasa and 500 in Brazzaville.

### Study of Future Microwave

Anyone familiar with the size and topography of our country will agree that it would be impractical to inter-link all our future provincial stations, such as Lubumbashi, Mbandaka, Kisangani, Bukavu, Lulua-bourg and Matadi, with microwave facilities. The cost would be too high and the technical personnel required to maintain the equipment would be difficult if not impossible to find.

FIG. 4 One of the three zoom-equipped PK-330 vidicon cameras.

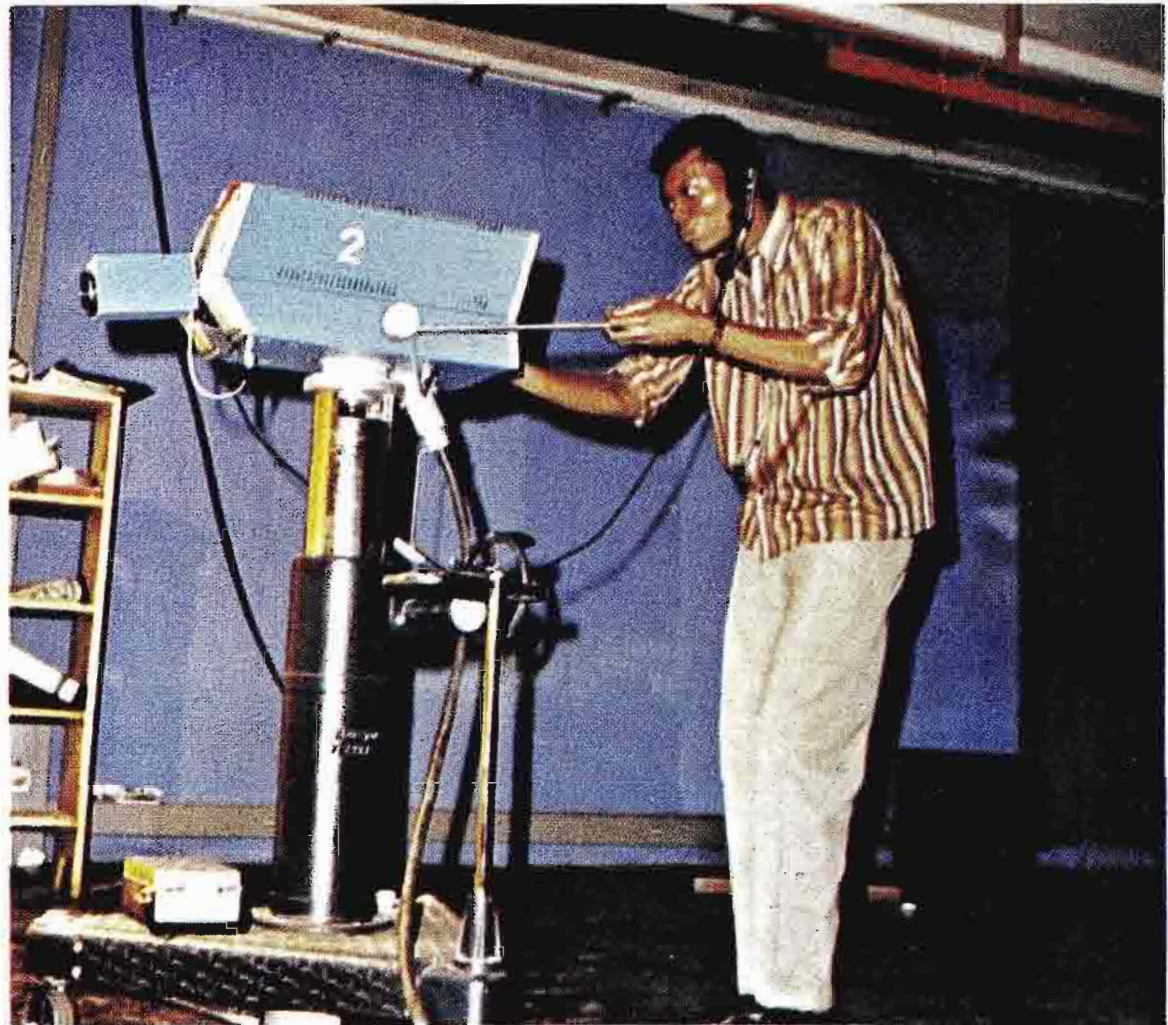

This is not the case for the Bas-Congo area between Kinshasa and Matadi, however, which is one of the most populated areas of the Congo. Accordingly, our technical services are presently studying a microwave plan with several low power repeaters all automatically controlled and monitored from our Binza transmitter site.

### Reliability A Must

As the reader of this article will detect, we, at our location in the Congo, are very concerned about the performance and reliability of our equipment, and, primarily to compensate for the lack of technical experience in our personnel, we have duplicated all equipment and facilities in the station (when the new transmitter is in operation, "old faithful" will become a standby). This redundancy eliminates all panic in case of failure of any piece of equipment since the responsible technician can punch up or cross patch the replacement unit in no time. We have pushed this concept even as far as the source control monitors. In case of loss of picture due to a faulty monitor, a standby unit can be punched up, and all signals available in the station can be monitored. Thus even our program producers have no reason to panic over equipment failure or poor technical performance.

### Some Commercial Programming

Radio Television Nationale Congolaise is a Government owned station, operated as a national service by the Ministry of Information. To provide additional income, the station accepts spot advertisements to be broadcast just after the evening newscast. There are

no sponsors for regular programs which are now broadcast from 7 to 11:30 pm daily. All national and international news is filmed and transmitted over the National TV network. The station also subscribes to international news agencies and uses news relayed by the national news agency, ACP, or "Agence Congolaise de Presse." Sunday afternoons, the station telecasts sport events picked up by a remote three-camera mobile unit.

### Educational Programs

Soon, RTNC will start educational programs during the daytime, and receivers are being installed by the Government in schools, hospitals, clubs and public squares. A private film and TV recording center will come into operation later this year and will provide about 15 hours of taped or filmed educational programs to be shown over the national networks each week. Although all programs will be recorded on film or video tape, the recording center will be linked with RTNC via microwave, thus allowing its use on special occasions for direct transmission.

### TV Standards

Sound and visual carrier frequencies are respectively 189.75 and 183.25 MHz, with FM sound and negative picture modulation. Operation is on the CCIR 625 "K" standard adopted by all French speaking African nations several years ago and on which neighboring Brazzaville has been transmitting since 1963.

### Studio Facilities

Studio and control rooms are located within the Min-

istry of Information grounds and almost adjacent to the radio studios: The buildings were originally designed in 1964 for a much smaller operation, and although several rooms were rebuilt and an entirely new film section was added, more space is still needed.

Awaiting the construction of a new "TV house", the station has converted a large villa surrounded by colorful tropical vegetation into technical rooms, and added a 40 by 40 ft. quartz lighted studio, two floors high, together with rooms at the rear where the transmitter is located.

Lighting control consists of a 120 input/output patchfield corresponding to the same number of studio outlets. These outlets can be grouped and set up in three scenes. A total of 12 dimming circuits can be used and programmed into any scene. The lighting engineer has four picture monitors next to his control console allowing him to judge the picture quality of all three cameras together with the outgoing program. He is also linked into the intercom circuit.

### Control Room

The studio control room and an announce booth are located on the first floor and look down into the studio. Studio control, which is used also as master control, contains three "New Look" control consoles facing a custom built monitor rack under which are controls for three PK-330 studio cameras and two film cameras.

Several other functions are remotely controlled from this one location such as the operation of videotape recorders and a PK-301 caption scanner, sync change-over switching, adjustment of studio and film camera levels, stabilizing amplifier settings, and the operations of two level balancing switchers, allowing any signal in the station to be checked on the engineering picture and waveform monitor.

Each camera has its control position with picture

and waveform monitors. Above the control area are picture preview and live monitors.

The program director's desk contains the PTS-1-8/3A Video Switcher and all start and stop buttons for 16mm projectors, slide projectors and tape recorders. The program director has full station intercom and studio interphone facilities at the tip of his fingers. A master BC-7A Stereo Console is the heart of the audio system. The stereo feature offers full standby facilities in case one channel fails. The remaining audio complement includes two BQ-51 Turntables, three RT-21B Reel Tape Recorders, an RT-17A Cartridge Tape Recorder and remote controls for the cassette players and for two of the RT-21B Tape Recorders which are rack mounted.

### Film and Tape Room

Space limitations made it necessary to install tape equipment, film projection, and film recording equipment in one room. But in this room is an elaborate film section fully equipped to allow the taking, developing, editing or post synchronization of any 16mm black and white film material.

Film equipment includes two multiplexed TK-22 film islands. One is equipped with a double band 16mm optical/magnetic projector. With this projector one motor drives a standard 16mm film and simultaneously a 16mm perforated magnetic tape. This equipment is used for news reels and also for language dubbing of standard film material.

The second island has two TP-66 Film Projectors and a TP-7 Slide Projector, all remotely controlled. One of the TP-66 Projectors is selsyn locked to a PM-76 16mm sprocketed film recorder and playback unit. This PM-76 is a backup for the double-band system in the other film island.

The caption scanner and document reader, which is basically a studio sync driven PK-301 Professional

FIG. 5 Camera control position, showing the program director.

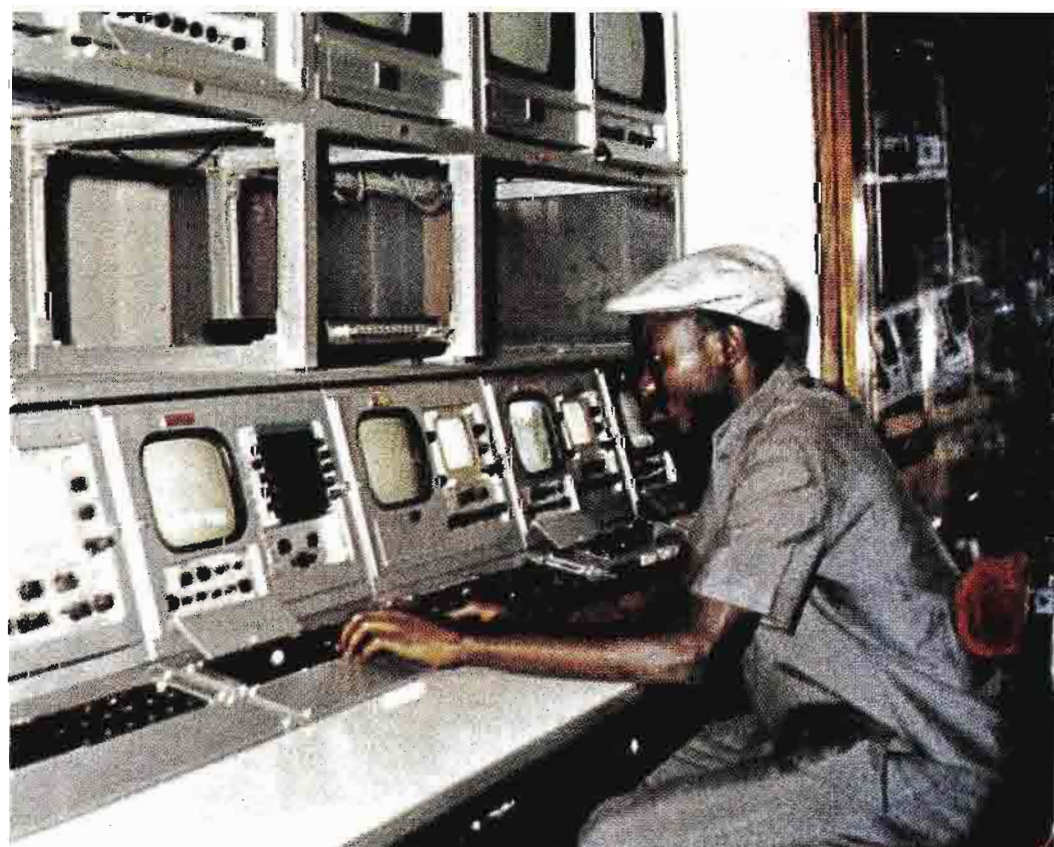

FIG. 6 BC-7A Console uses stereo channel for standby.



FIG. 7 Film islands are used for newsreels and for language dubbing.

Camera on an adjustable stand, is a very valuable accessory and is used for all program identification and time clock transmissions.

On the opposite corner of the room is a remotely controlled TR-4 Tape Recorder with provision for a second unit (the mobile TR-5 is sometimes rolled in there when back-up is required). Next to it is a TFR-1 TV Film Recorder, an equipment that will be used extensively when the educational programs commence. It will allow recording and later duplicating for school distribution purposes all programs which are generated in the studio.

### Transmitter Room

Transmitter equipment is crammed into a small space, but, as explained earlier, a new transmitter site will soon be in full operation. With the present TTL-500H-N Transmitter, there is one rack with the usual input and monitoring equipment. Another rack contains the two TVM-6 Microwave Transmitters which will relay the TV picture to the Binza site, and a TVM-6 Receiver which is the studio end of the remote mobile unit microwave link. Engineering components and spare modules are kept on hand for all equipment.

### Mobile Unit

We are very proud of our TK-71 Remote Pickup Truck decorated as it is in the national colors. It is our show piece and it excites the curiosity of hundreds of children and grown-ups wherever we stop for broadcasts.

The truck has a glass-fiber front end and aluminum body. It has the necessary roof platform, camera hoist, storage compartments, and is fully air-conditioned. A heavy duty 25KVA gas generator trailer provides a reliable power source for locations where the mains may be somewhat unstable. Television facilities include three vidicon cameras, a TR-5 Video Tape Re-

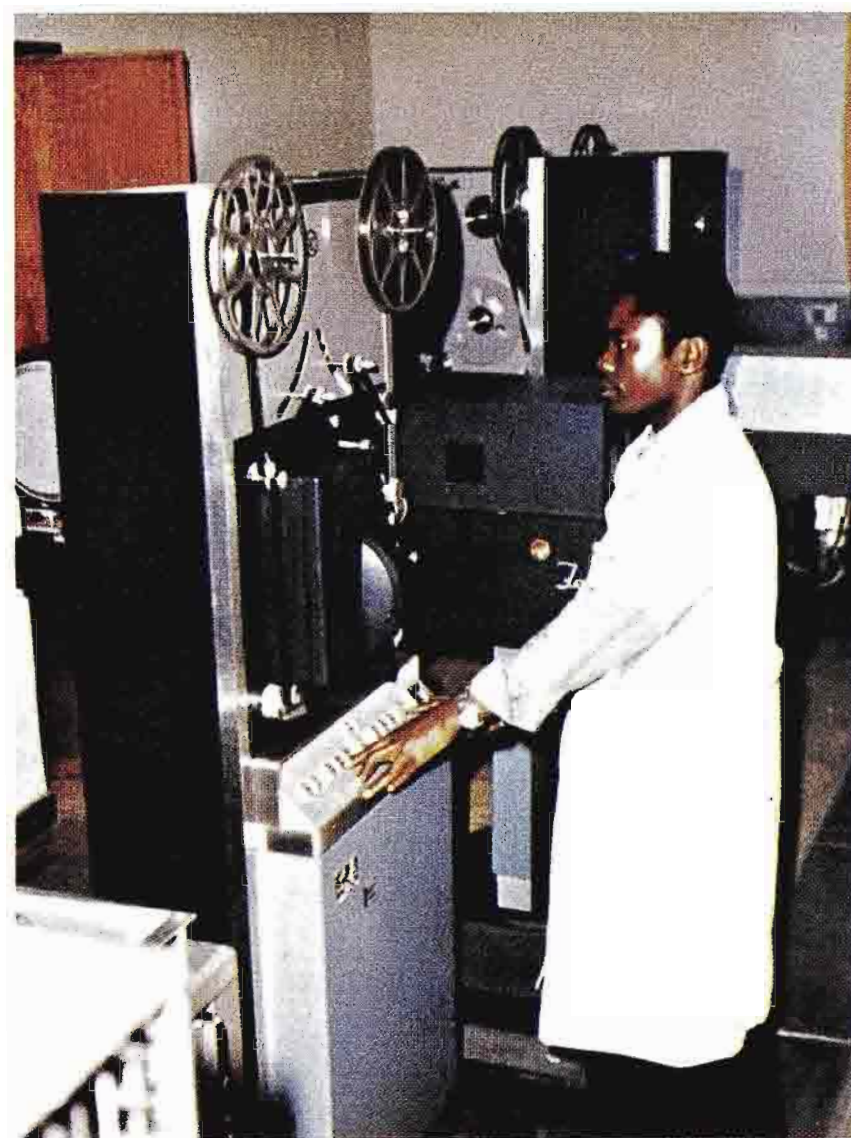

recorder, PTS-1/8B Switcher, TG-3 Generator, and BN-16 Audio Console, or exactly the same basic equipment as in the studio. There is enough space on hand to replace the present vidicon cameras with image orthicon cameras and the switchover can be done with minor expense.

### Administration

The Minister of Information has authority over the Congolese radio and TV services and is assisted in his duties by a Secretary General. Under the Secretary General there is a director of TV (my direct superior) who is responsible for finances, programming, personnel, transportation, servicing and other aspects related to the operation of the station.

### Technical Personnel

Standardization of equipment is of great help to us from the point of view of personnel training as well as maintenance engineers.

Readers may be surprised that we do not have I.O. cameras. This was done purposely in order to allow our not yet skilled people to obtain good pictures. We have, however, planned to replace our vidicon cam-



eras with I.O. or plumbicon cameras, at a later date, and the switch-over will be an easy operation.

Our PK-330's will then be sent to the provincial stations and should give many more years of virtually troublefree life. The question may also be raised how we successfully manage to use vidicon cameras outside. Under the Congolese bright sky this is no great difficulty and we use our three remote cameras until right before dark. Just below the equator it takes only about 15 minutes for the darkness to set in by which time we have our stadium light projectors in operation. The transition period is very short and the program, if it has to continue, goes on without too much loss of picture transmission. During one football transmission, we all remember that the commentator had to look at his monitor to get a better, more detailed picture than he could get by looking directly at the players.

FIG. 8 PK-301 camera as caption scanner for ID's and time announcements.

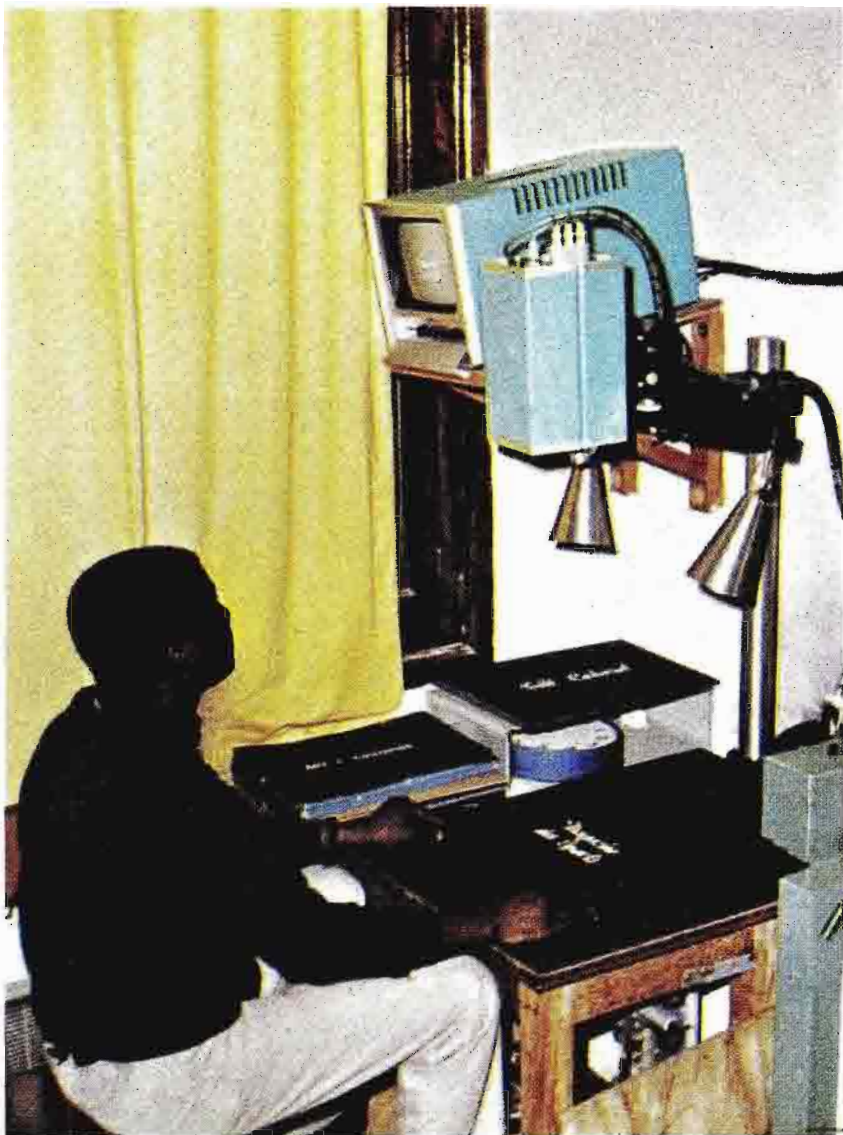

FIG. 9 Tape facilities include remotely controlled TR-4 Tape Recorder and TR-5 Mobile Tape Recorder.

## Conclusion

In summarizing, I must reiterate the important role speed of installation and durability of equipment played in helping the Congo enter this TV world, and the responsibility which was so expertly fulfilled by RCA.

Knowing well that electrical and mechanical components are not normally available in our part of the world, and not wanting to risk having to wait for a part during installation, RCA reproduced in their factory the exact floor layout of our master control and film rooms, complete with ducting. This allowed the prewiring of all racks and the termination of all inter-rack cabling. This also allowed pretesting of units the way they would operate in Kinshasa. When the prewired and preassembled equipment arrived, the changeover was completed in two days. On the third day, operators, producers, and engineers were trained on the new equipment.

I do not claim that by the summer of 1967 the Congo had the largest TV studio but certainly one of the most modern and homogenous TV stations in Africa. This success was due to the ideal working relationship between RCA's sales engineer, P. C. Berben, and the hard work performed by the installation crew under the guidance of the old timer, Bob Marye.

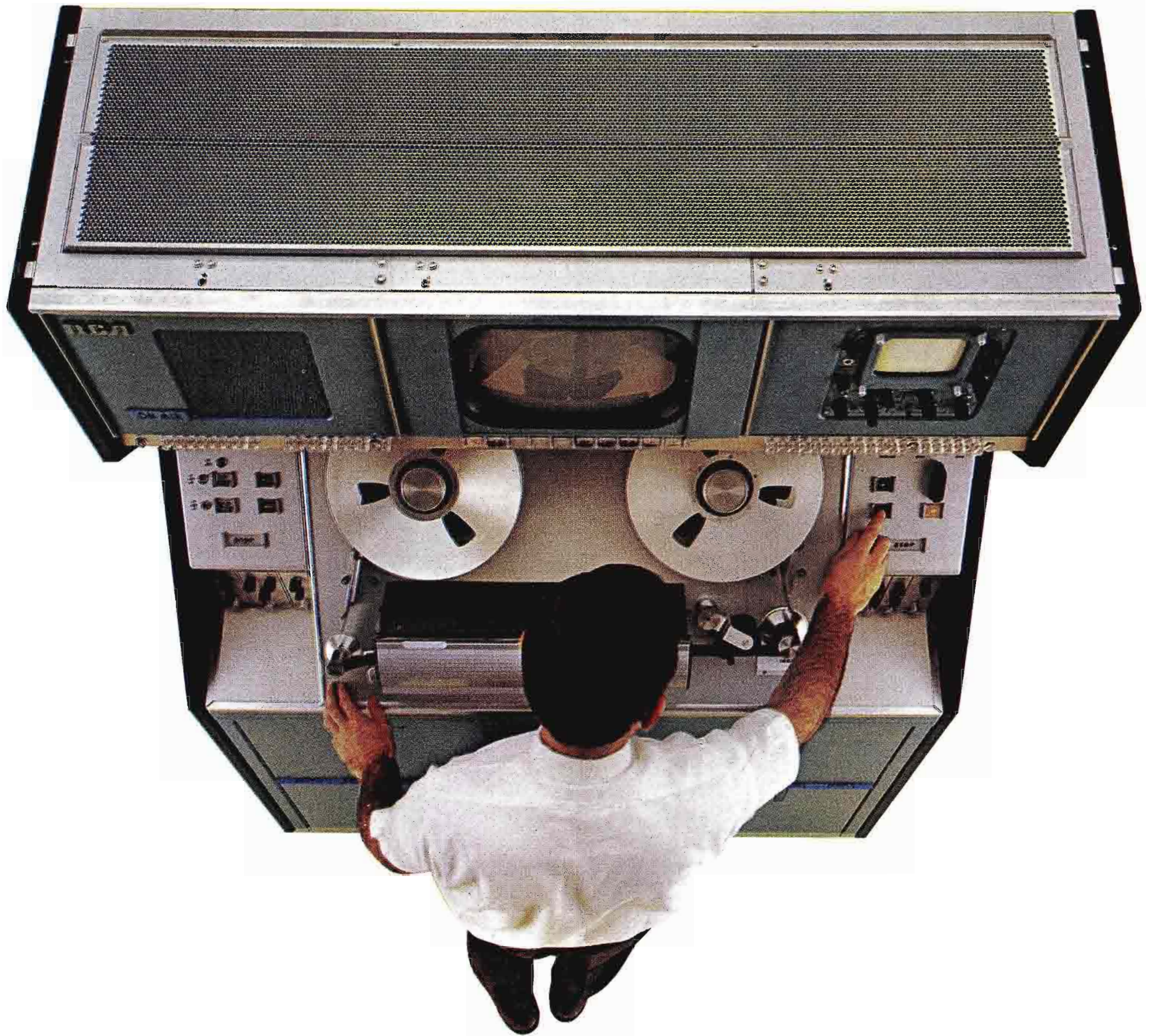

## In The TR-70B The “B” Is For “Brains”

Here's A New Recorder That  
Does Much Of The  
Technical Thinking  
For TV Tape Operators

Brains? Well, not really. Intelligence? Maybe in a computer sense. But how do you describe a tape recorder which makes many of the technical decisions previously relegated to your video tape operator?

You describe it as the TR-70B.

Here is a new recorder . . . latest in the RCA TR-70 series . . . with more automatic safeguards for color tape quality than any other recorder available today. These safeguards automatically perform highly sophisticated technical functions, thereby permitting the operator and his brains to handle many more of the tasks that only an operator can do—load, setup, make qualitative picture decisions and perhaps handle more machines than he can now.

The following are some of the electronic assists to the video tape operator—assists that make both man and machine better performers:

OPERATOR'S CHOICE of automatic or manual FM standards selection and automatic stop cue is available on this push-button panel.

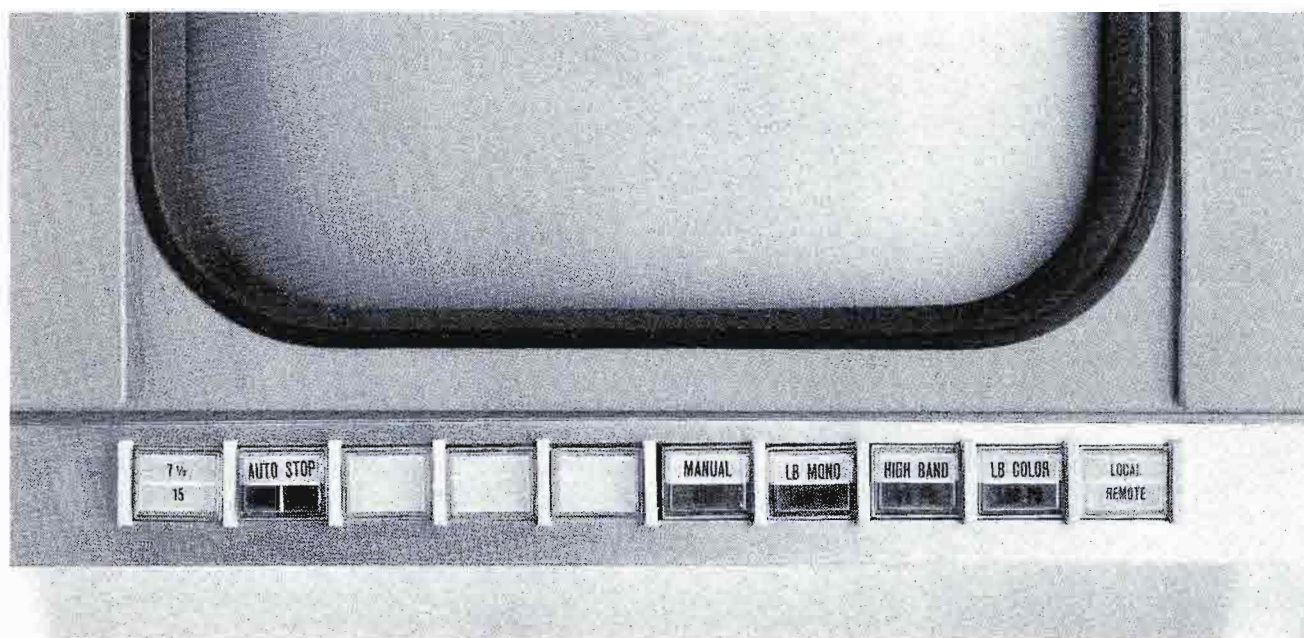

### He Can't Play A Tape At the Wrong FM Standard!

An exclusive feature of the TR-70B, the Automatic FM Standards Selector, senses blanking frequency and switches the machine to the appropriate FM standard—highband, lowband monochrome or lowband color. An unknown tape can be played without the operator having to research its origin.

What does this mean to actual operation?

If, for example, a highband recording is replayed in the lowband mono standard, the conventional tape machine reacts violently—with picture breakup, head-wheel not locked, etc. This would be obvious to an operator, but he may have already lost a commercial or portion of a program before he can correct the situation.

Or take another, more subtle condition on the same conventional machine. Suppose a lowband recording is played on the highband standard. This time the

machine reacts less violently. However, the result is a picture with somewhat less than the best quality.

With the TR-70B these situations cannot exist. There are no more goofs. And there's one less worry for the operator.

### He Can Pre-Cue Commercials For Automatic Playback!

An automatic "stop cue" device on the TR-70B permits pre-cueing of tapes by recording a tone burst on the audio cue track. This tone is sensed by the machine to stop the tape at the precise point the commercial is to begin. An end cue can also be recorded to stop the machine at the completion of the commercial or program segment.

Now the operator can pre-cue tapes on several machines so that they are ready to roll automatically at a signal from a remote point . . . and another worry is eliminated from the crucial station break period.

AUTOMATIC COLOR QUALITY options, Color Dropout Compensator, left, and CAVEC, right, are shown partially removed from module bank.

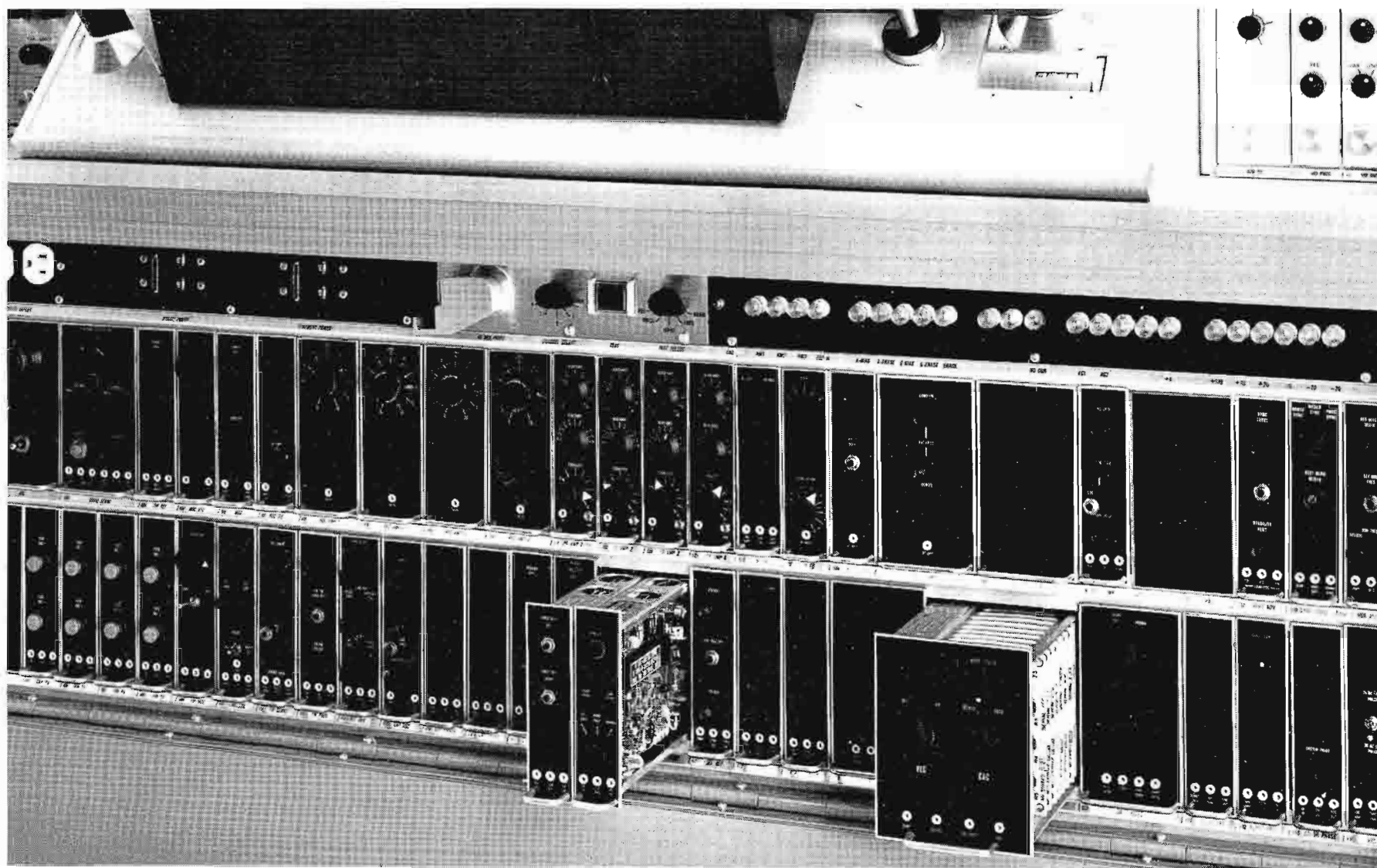

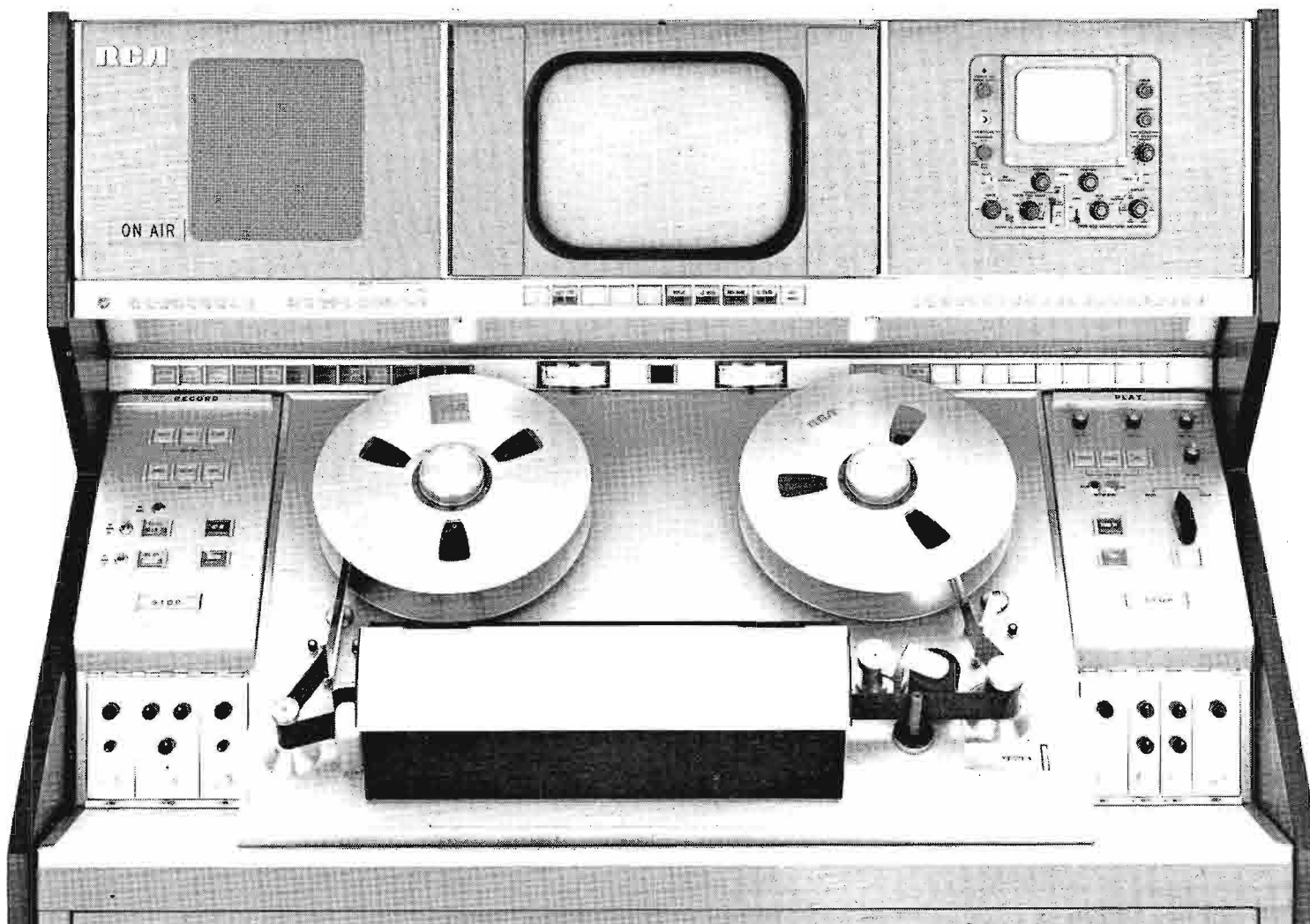

EXPANDED WARNING SYSTEM includes more indications than ever before of setup errors and machine malfunctions.

POSITIVE-LOCK REEL HUBS handle the most slippery of plastic reels, assist in cueing commercials and other tapes.

### He Can Rely on CAVEC and the Dropout Compensator to Automatically Correct Color Errors on Replays!

Automatic color quality control is another exclusive that can be obtained with the TR-70B. An accessory CAVEC module (Chroma Amplitude and Velocity Error Corrector) automatically eliminates all forms of color banding which have previously plagued the color tape user. This device employs integrated circuits throughout its design. It has the unique capability of correcting not only color errors between bands, but because it corrects each line of the band, it also eliminates color errors within bands.

Sure, skillful operators have been able to laboriously tweak out some, but not all, of these picture disturbances, but now this can all be accomplished automatically by CAVEC. The result: elimination of what might possibly be the video tape operator's biggest worry.

Another accessory is the Color Dropout Compensator which corrects for the inevitable dropouts found in so many video tapes. This RCA unit is unique in both its plug-in design and its ability to insert correctly phased color information within the period of the dropout. This virtually eliminates any visible effects of correction in the final color picture. Circuits built into the dropout processor module of this unit permit instant setup to further unburden the operator. These circuits simulate a dropout so that it may be quickly tuned out and the machine can handle any further color discontinuities automatically.

### He Has More Control Than Ever Before Over Machine Performance . . . With Automatic Warning of Malfunctions!

Another time saver now incorporated into the TR-70B is a record optimizer. With this device headwheel re-

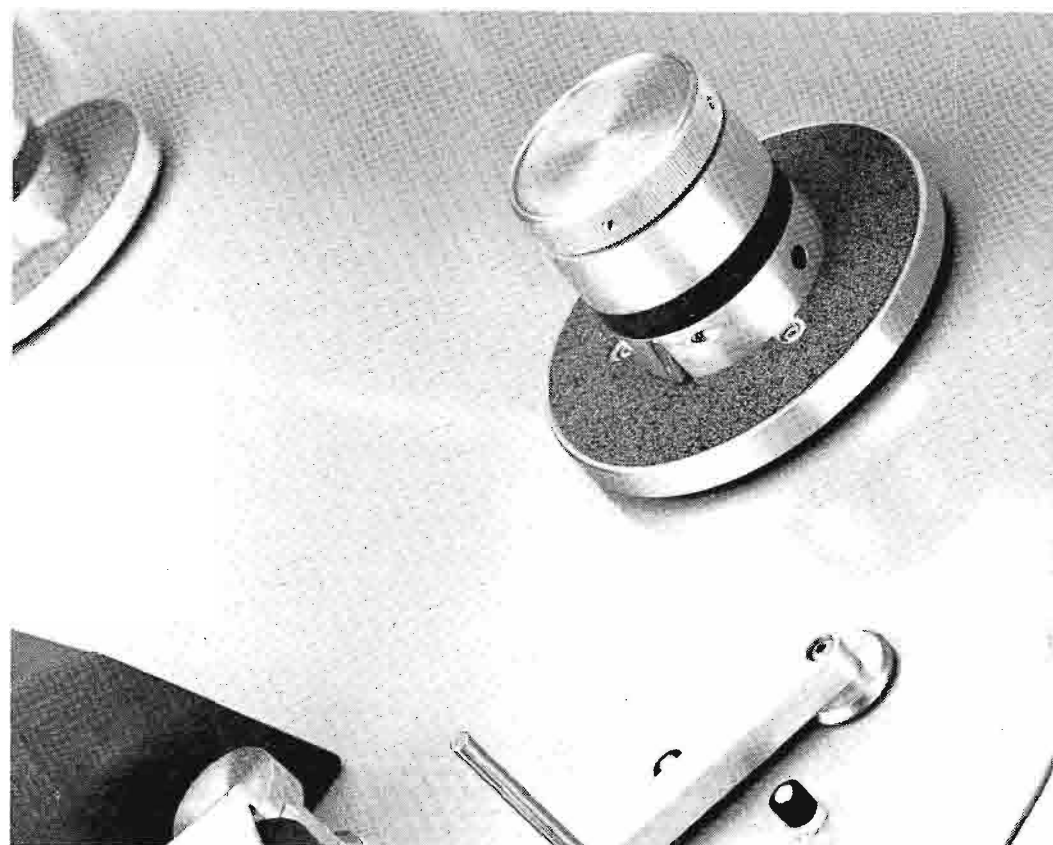

SCRATCHLESS ERASE HEAD erases from base side of the tape to eliminate any possibility of scratching the oxide.

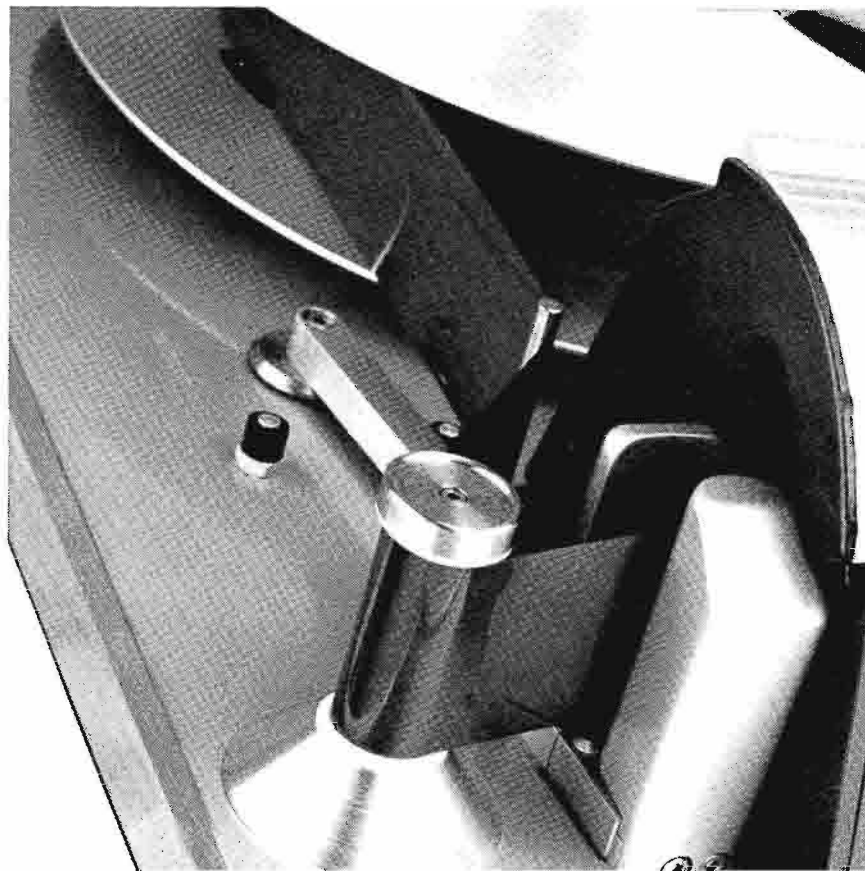



AUDIBLE WARNING alerts operator if he is out of sight of normal visual indicators—keeps him informed even if he's blindfolded.

cord currents can be optimized in a matter of seconds rather than the minutes required by previous trial and error methods. In setting up he gets top performance from the machine quickly, and sets his mind to other duties.

The warning system, so valuable in previous TR-70 models, has been expanded with more indications of possible set-up errors and machine malfunctions than ever before.

The new system includes a central warning light. Should any of the warning signals light up, this light also flashes a central warning for the operator in case he may be out of sight of the normal indicators. Should he be out of sight of the machine, a warning buzzer alerts him of trouble. The TR-70B can keep him informed even if he's blindfolded.

### He Gets New Opportunities To Make Tapes of Which He Can Be Proud!

Many more features are part of the TR-70B, such as a rear-side erase head to prevent scratching the oxide side of the tape, new positive-locking reel hubs for non-slip handling of reels, pre-wiring for plug-in addition of Electronic Splicer, Tape Editing Programmer and Color Dropout Compensator accessories, and a new high gain servo to permit color editing free from color field discontinuities. They are all described in technical detail in a booklet available for the asking. Write Editor, BROADCAST NEWS, RCA, Camden, N. J. 08102.

Show it to your video tape operator, and he'll affirm that in creative hands the TR-70B is the one recorder to produce the tops in tv tape.

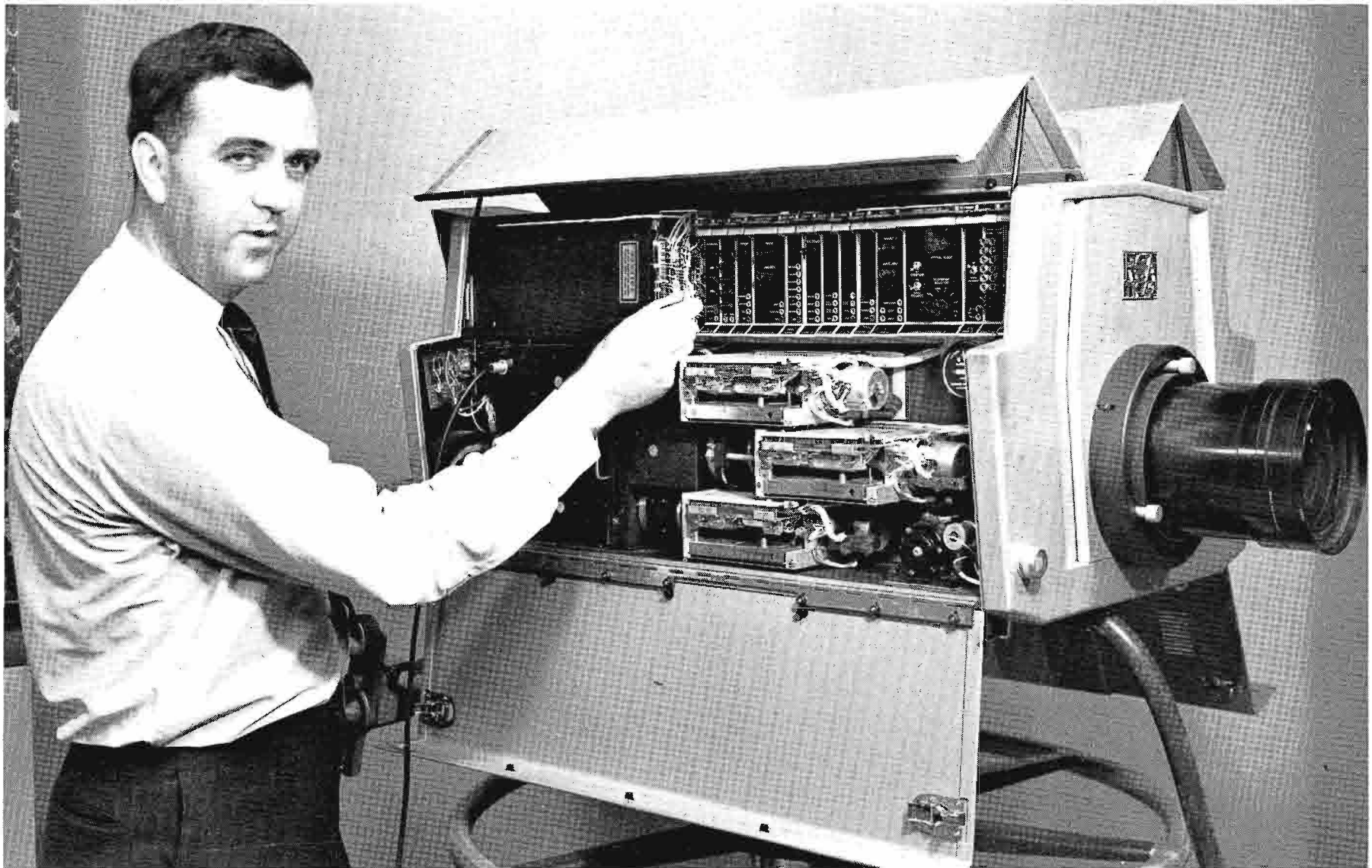

FIG. 1 The author at a TK-42. This article is based on his experiences in assisting numerous customers with the installation and operation of their cameras.

## How To Get The Best Color From Your TK-42/43 Cameras

R. C. PARKHILL,  
Camera Equipment Merchandising

Over 400 TK-42/43's have now been installed in the field. In the course of working with many customers, a number of setup and operational techniques were found to be critically important to color quality. This article points out these areas and describes many hints and procedures which have helped customers to attain the very best performance from their cameras.

Regard the camera as being built of three units:

- (1) a 4 1/2" image orthicon camera
- (2) a 3-vidicon color camera
- (3) an encoder

We will deal with the optimization under the following headings:

- |                        |                  |
|------------------------|------------------|
| (a) Image orthicon     | (d) Registration |
| (b) Vidicons           | (e) Video system |
| (c) Focusing of optics | (f) Encoder      |

### Image Orthicon

The 4536 image orthicon will provide the highest quality image for the TK-42. However, it will only give its best if set up correctly. It can be stated categorically that if a TK-42 (or 43) has a poor image orthicon, the final picture will be poor regardless of how excellent the rest of the system has been adjusted.

The main factors involved are signal/noise and resolution, and these two factors can be compromised by one control-target, see Fig. 2. The target voltage

should be set as high as possible (to get high signal/noise ratio) while still retaining good resolution (at least 700 lines limiting) with acceptable microphonics and sensitivity. It should be noted, however, that at high target voltages (approximately 4V above cut-off), the G4 (orth focus) control setting is critical and care must be taken to have high horizontal resolution while avoiding excessive "spiking" on black/white transitions and loss of vertical resolution. If flicker is encountered, first check the Vert. Drive delay setting and, if necessary, then slightly readjust Hor. Align control to eliminate the flicker. If a large adjustment of horizontal alignment is required, then target voltage should be reduced.

The installation of the "Video B" modification, see Fig. 3, to mono channel video module reduces low

frequency streaky type of noise to a very low level, thereby allowing a high S/N ratio to be achieved in the mono channel. It should be noted that essentially all the noise in the final color picture originates in the mono channel.

Gain (orth or dynode gain) should be set, as per the instruction book, such that when the gray scale is exposed to put the white chip  $\frac{1}{2}$  stop over knee, the video level measured from back porch to the white chip level is equal to the test pulses measured from back porch level to the top of the pulses, Figs. 4A and 4B. Care should be taken when finding the knee that the compression of the whites is, in fact, due to the knee action and not due to lack of beam. Beam should be finally set such as to limit at approximately 110 to 115% level on medium area whites.



FIG. 2 Adjustment of target voltage.

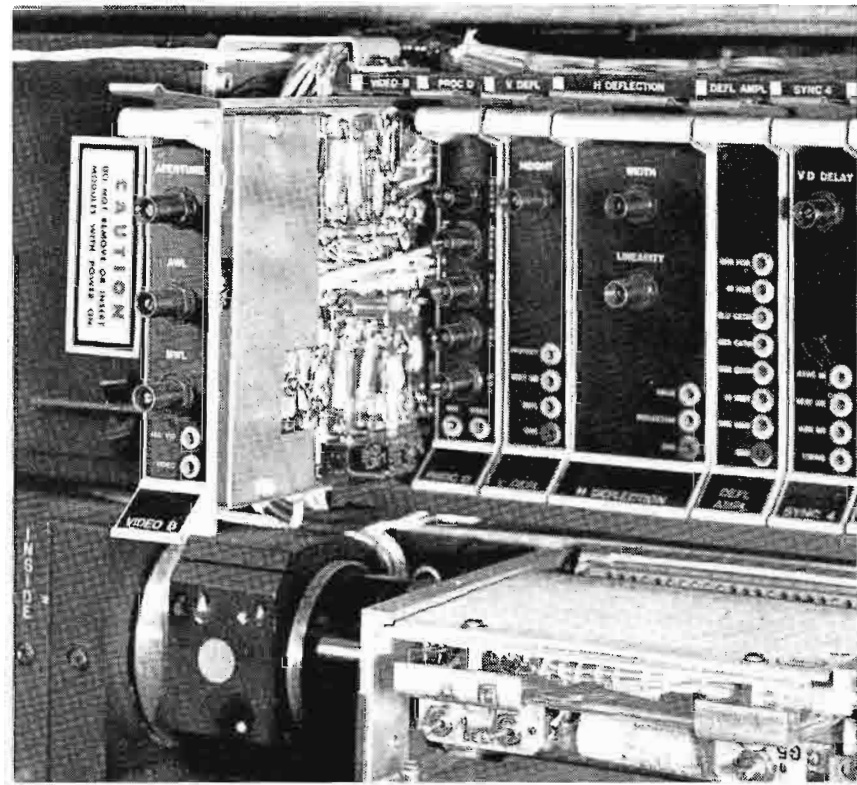

FIG. 3 Video B module for improved S/N ratio.

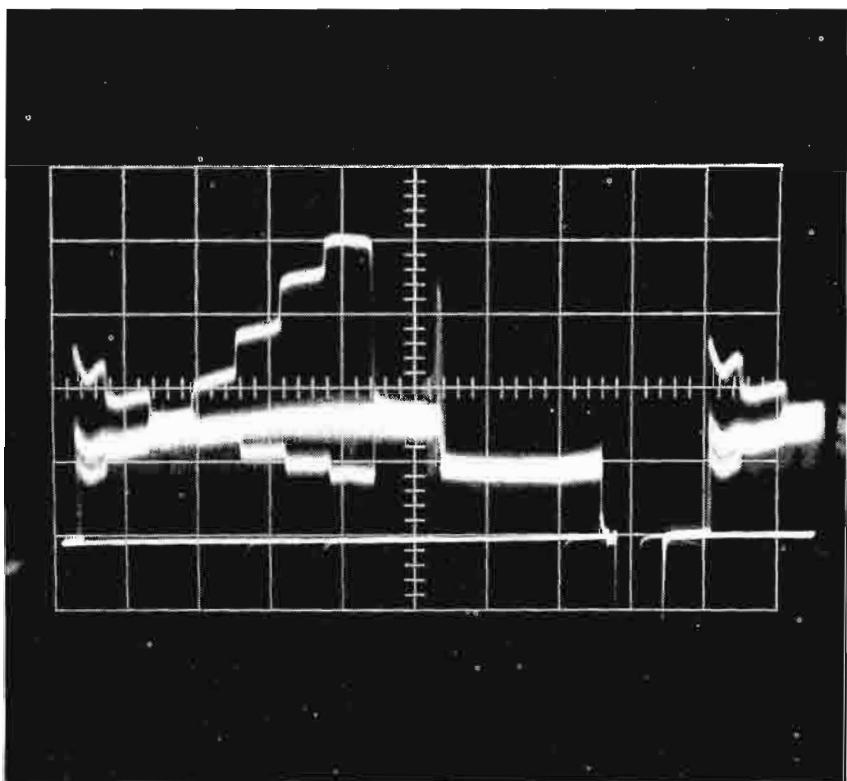

FIG. 4A Image orthicon exposed with white chip exposed one-half stop over knee.

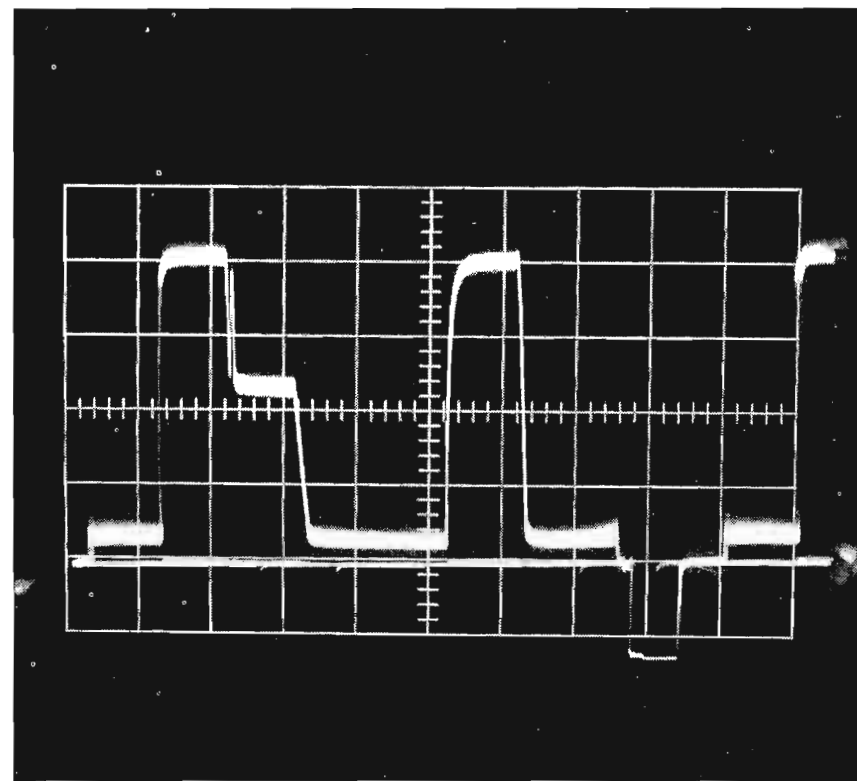

FIG. 4B M-channel reference test pulses.

*Orthicon video and channel test pulse levels are compared using back porch as the reference datum. Note that the reflectance chart may be "off centered" to place the white chip in the center of the raster, thus averaging out any orthicon white shading, because in this measurement we are only interested in video amplitude.*

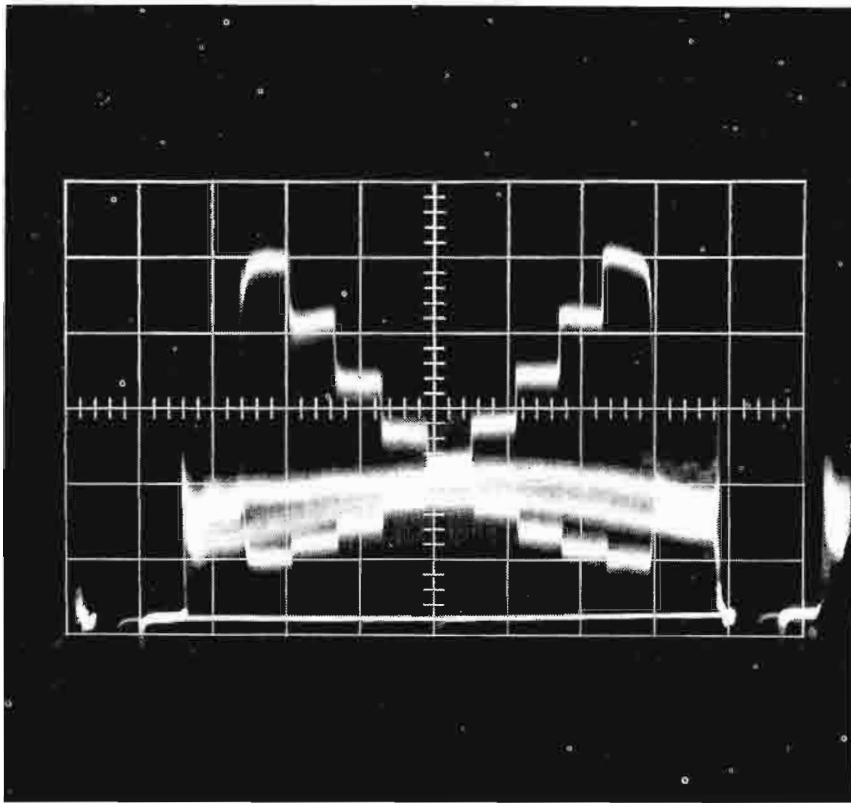

FIG. 5 I.O. exposed to put white chip at knee.

Mono Gamma switch should be set at "A"—which is 0.7 correction. If a Proc. D is in the mono channel, then set gamma control slightly CCW of mid-range. This is approximately 0.7 correction. Do not use excessive gamma correction as this will increase noise. 0.7 correction is applied when, with I.O. exposed exactly to knee on log. reflectance chart, "cross over" point of chart is approximately 30 to 35% of video (measured from black chip to white chip) above black chip. See Fig. 5.

Check that Break and Slope controls are always fully clockwise.

### Vidicons

One of the important points in assuring optimum performance of the vidicons is to be sure that they receive the correct amount of light. This is achieved by carefully selecting the I.O. neutral density filter as described in the instruction book. Check Iris calibration on TK-42; on TK-43 read iris direct on external lens.

A quick check of iris calibration on the TK-42 can be made using the fact that maximum iris opening of the lens when on its close-up range (8-40 or 3.2-16) is f/8 and on its wide angle range (4-20 or 1.6-8) is f/4. Exposing the camera to a scene on, for example, the close-up range while viewing a waveform monitor, the iris control is turned from approximately f/16 through f/11 until the video level just stops increasing. At this point the iris is now wide open and the control should read f/8. A similar procedure may be used to check, with lens on wide angle range, the f/4 setting. A visual check of the iris can be made by looking down inside the lens from the front of the camera, it being helpful to have the lens zoomed to a long focal length.

If the vidicons are operated at a lower than standard light level, then higher than normal target voltages will result which may lead to image retention (re-

tentivity). Conversely, if the target voltages are too low, lag may result.

If black level shading is noted on a vidicon, check G5 adjustment as detailed in the instruction book.

The preamp gains on the Red and Green channels should not be set higher than necessary, to prevent the noise experienced at higher settings from becoming noticeable in the final encoded picture. However, it may sometimes be found necessary to operate the Red preamp at a gain of 100 if the 0.3 N.D. filter in the indoor/outdoor filter assembly is constantly kept in the light path while the camera is operated under normal studio lighting color temperatures.

The Blue preamp may be operated at any gain setting, the lowest gain setting being chosen where, at the operating target voltage, no retention is noticed and sufficient manual black level control range exists.

The Beam control, on most vidicons, has no effect at normal light levels. The Beam control should be set at its most counter-clockwise position where the undischarged trails on moving specular highlights are minimized. Be sure that beam alignment is correct.

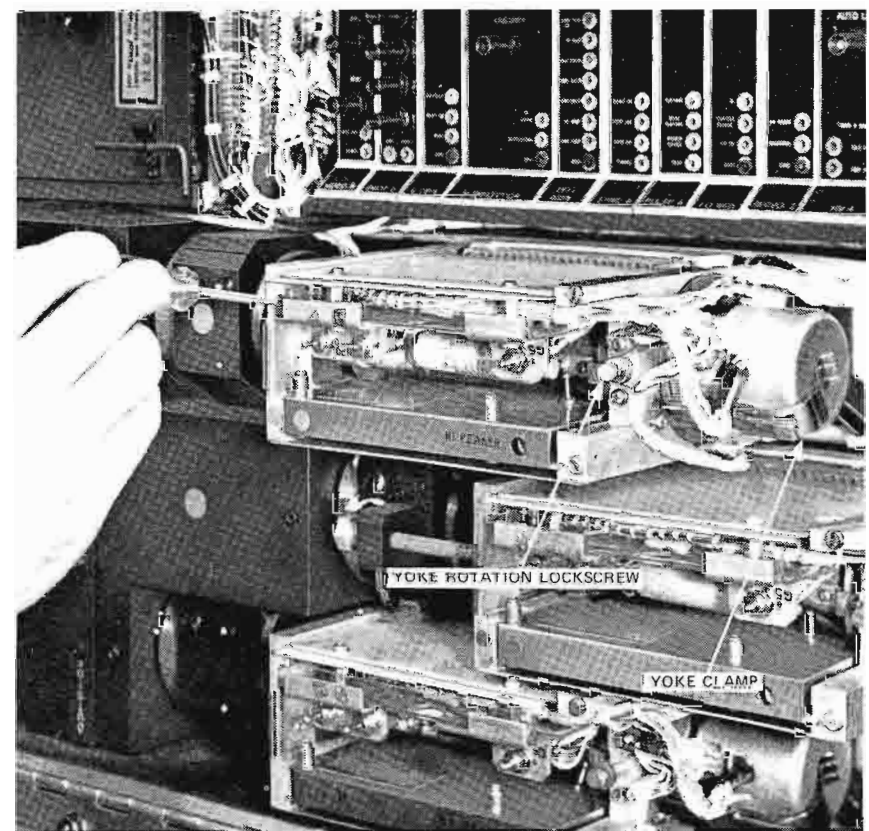

FIG. 6 Screwdriver is shown on vidicon locking screw.

It should be borne in mind that since the image size on these vidicons is only one half normal size, i.e., approximately 0.3 inch diagonal, mechanical rigidity of the yoke assemblies is important to insure registration stability. To this end, always ensure that the vidicon locking screw (located at the target end of the yoke assembly) and yoke rotation lock screw shown in Fig. 6 are firmly tightened and that the complete yoke assembly is solidly clamped to the camera chassis.

To set vidicon preamp high peaker, frame reflectance chart normally in scan. Then pan camera left so that upper white chip is in center of scan. Set the high peakers so that no streaking or black overshoot follows this white chip. Check results at the remote control



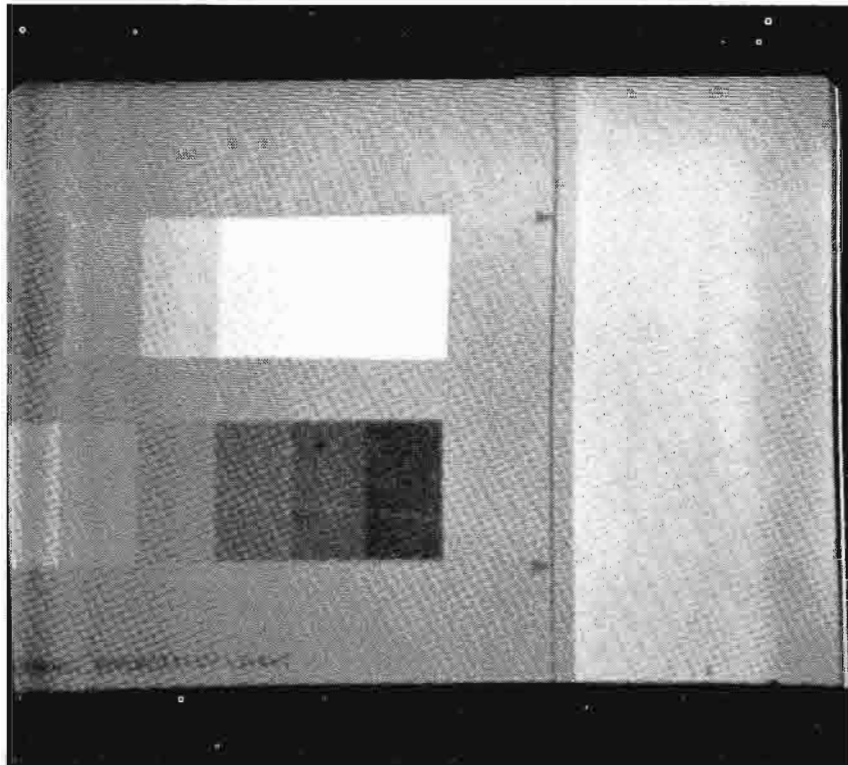

FIG. 7 No streaking or black overshoot should be seen following the white chip.

position monitor. If it is impossible to remove all streaking from a given channel, then make the other two channels the same. See Fig. 7.

Slight readjustment of the Preamp D bias frequently allows a more satisfactory Hi-peaker setting.

### Focusing of Optics

Before attempting any mechanical focusing adjustments, always make sure that the *iris* is at its *widest open* position, to achieve the most critical depth of field. First the I.O. is positioned so that the image is always in sharp focus at all settings of the zoom control for a given object-to-camera distance. When doing this operation (as detailed in the instruction book), the object should be as far away from the camera as is practicable. It is useful to use a resolution chart *at least* 35 to 40 feet away from the camera.

Then the vidicon objective lenses are focused, so that the vidicon images are as sharp as possible when the image orthicon is sharply focused. It is important to do this adjustment as critically as possible to avoid colored fringing on specular highlights. If the focus tracking is poorly set up it can give the effect of misregistration in the final picture.

Always remember to retighten the objective lens clamp locking screw when adjustment is completed and unscrew the clamp expanding screw (where fitted) before tightening the locking screw. See Fig. 8.

### Registration—Important Points

To assure stability, make sure that all yoke assemblies are rigidly tightened down mechanically to the camera chassis.

With the advent of the Video B module, it will be noted that the I.O. Horizontal Centering no longer has such a critical effect on the black “clamping bars” seen across top and bottom of picture and the “white level drop” condition has been virtually eliminated.

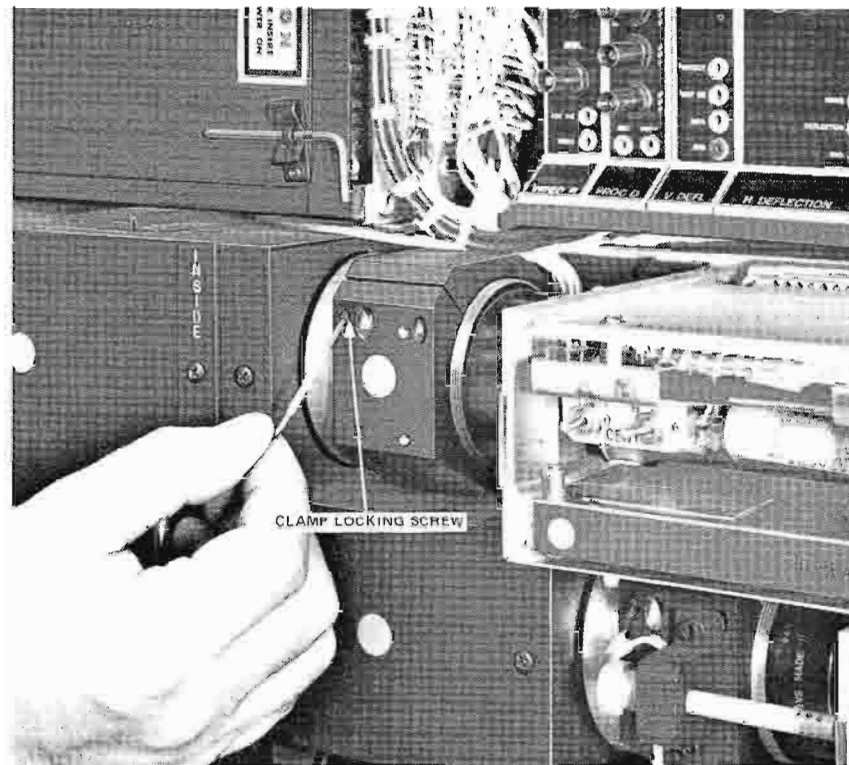

FIG. 8 Allen key shown on clamp expanding screw.

However, carefully (with camera capped) check to make sure that black clamp streaking is not seen at top and bottom of raster. Check that I.O. black level is not below clipping when making this adjustment.

When setting the Green Hor. Cent. to center the image of the field lens mask in the viewfinder raster, remember to have Color Bars on to get the monitoring system timing correct.

If the I.O. mirror is adjusted to achieve final registration between I.O. and Green, I.O. to Zoom Lens focus tracking must be readjusted, and don't forget to retighten the Allen head locking screw on the mirror assembly base plate, Fig. 9.

When adjusting height, skew and vertical linearity controls, consider only points on a vertical line through the center of the picture.

When adjusting width, yoke rotation and horizontal linearity controls, consider only points on a horizontal line through the center of the picture.

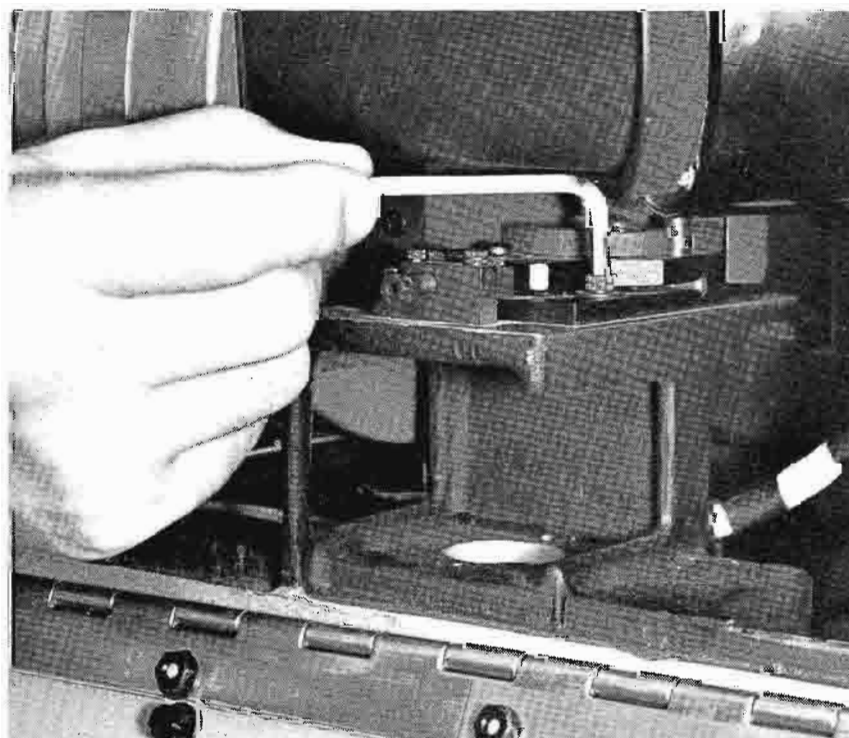

FIG. 9 Allen wrench on mirror assembly locking screw.

When all registration is completed, use the M (Master) Height and Width controls to recheck that the field lens mask as viewed in the Green channel is *just outside scan*.

Use negative polarity switch as an aid in registering and note that the Green channel stays positive—it is the size, centering and rotation *reference* for the complete camera.

### Video System—Check Points

Set test pulses as accurately as possible . . . Mono Black level just above clipping . . . Green Black level approximately 5-10% above clipping.

If Proc. D is used in color channels, note that since soft clipper cuts into right-hand test pulse, the Break control on the G processor must be turned out clockwise before test pulses can be made equal in the Green channel. Then, viewing color output, Red and Blue black level controls are adjusted for minimum subcarrier on left-hand test pulse. Red and Blue white level controls are adjusted for minimum subcarrier on right-hand test pulse.

Note again that if Proc. D is in color channels, the Red and Blue Break controls must be turned out (fully clockwise) before white controls adjusted for minimum subcarrier.

When setting mono/chroma ratio, i.e., G video equal to M video at desired point on I.O. transfer characteristic, see Figs. 10A and 10B, remember that if G is target adjusted, then G black level must be rechecked for correct level above clipping.

The further the I.O. is exposed into the knee while setting G video = M video on reflectance chart, the less color saturation there will be in the final picture.

Before adjusting Red and Blue targets, set gamma controls on processors fully counter-clockwise, then when a White and Black balance is obtained, gamma correction is added as necessary to achieve accurate gray scale tracking.

One useful way to determine how much gamma correction is required is to compare the Red, Blue and Green transfer characteristics at the remote control position using the B, R, G, M switches. Turning a gamma control clockwise effectively lifts the mid-gray area of the transfer characteristic. Of course, once a gamma adjustment has been made, MBL and target controls must be touched up as necessary to maintain white and black balance. The final assessment of the gray scale should be made by viewing camera output on a color monitor. There should be no color change visible on the gray scale steps when monitor is switched from mono to color. Note that many gray scale charts that have a background which is not neutral—it usually appears yellowish.

Once the best possible gray scale has been obtained, then the I.O. can be exposed over the knee and the Break controls set. Do not attempt to set Gamma Break (/Slope) controls all at the same time. Firstly achieve best possible gray scale with I.O. exposed

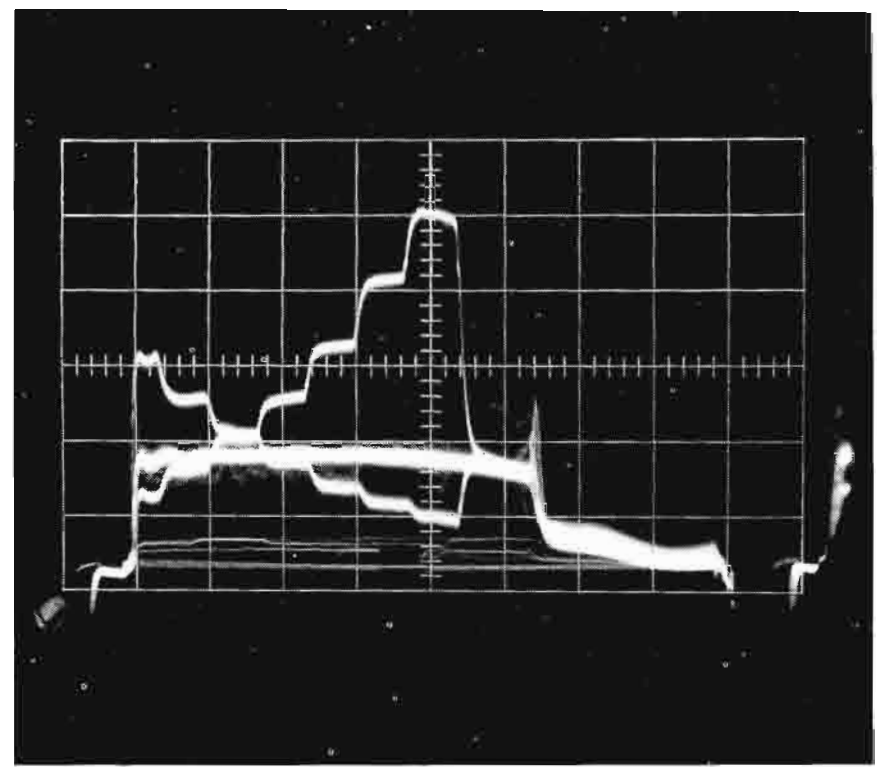

FIG. 10A M channel with white chip exposed just below the knee.

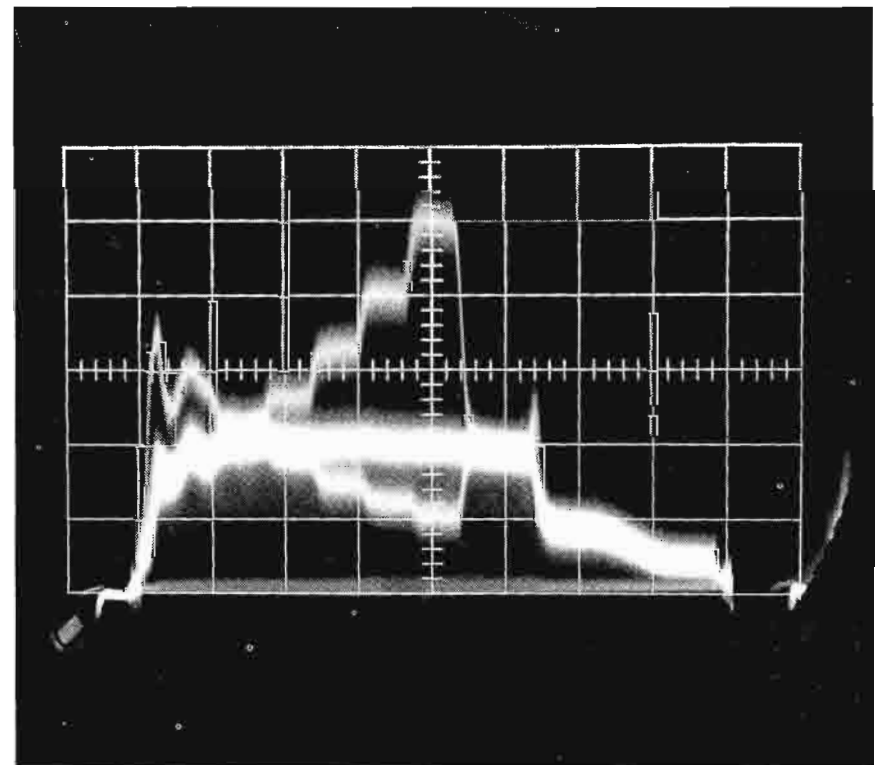

FIG. 10B G channel.

slightly into knee—then set break controls.

On Proc. B3—set for maximum compression of whites that gives zero subcarrier with I.O. exposed 1½ stops into knee.

On Proc. D—first adjust G break and slope controls for shape of Green transfer characteristic to be as close as possible to shape of I.O. with I.O. exposed approximately 1½ stops into knee. This is best done by comparing the relative level, on the two channels, of each of the four brightest chips on the gray scale above the black chip. For example, if on the I.O. the 3rd brightest chip is at a level 60 IRE units above the black chip, then on the G channel the same chip should be at a level 60 IRE units above the black chip. See Figs. 10C and 10D.

To avoid setting the breaks to clip too early, which can lead to “burnt out” face tones, it may be necessary to have the 60% reflectance chip on the G channel some 10 to 15% higher than the I.O., so that the lower chips can be equal on the two channels.

Then compare the Red and Blue channels each in turn with the G channel finally trimming the Break controls for zero subcarrier on Color Output.

At the remote control panel, ensure that all operators use the recently issued “Check List” before every taping or on-air use of the cameras. This check list,

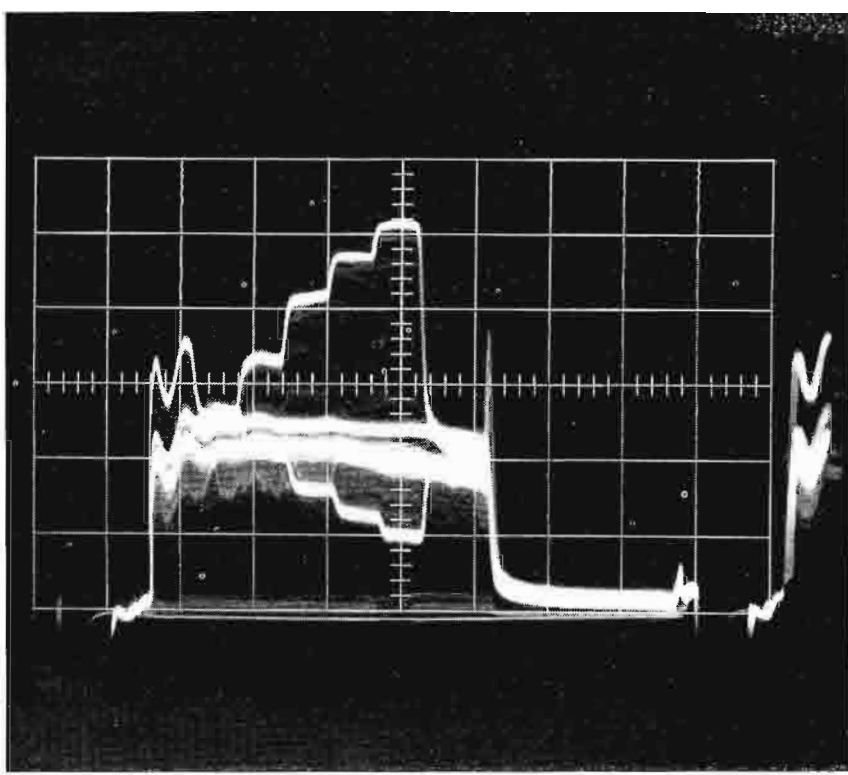

FIG. 10C G channel with Break & Slope set.

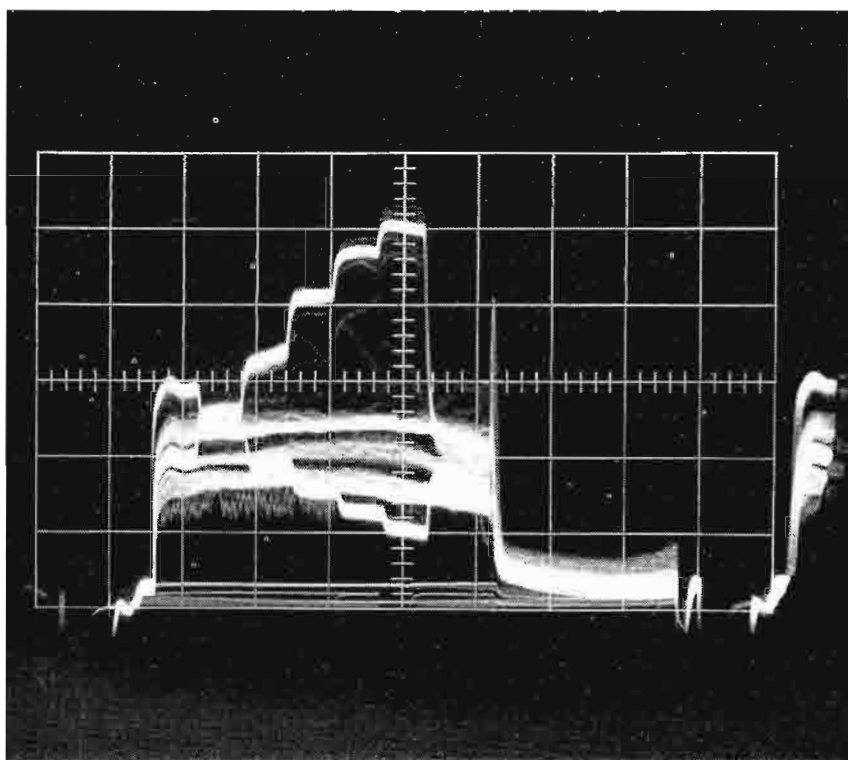

FIG. 10D Image orthicon exposed  $1\frac{1}{2}$  stops over the knee.

printed on metal foil, is designed to adhere to the blank panel adjacent to the color and mono remote control panels in the console.

Note that with the Proc. D, it is no longer possible to set the Chroma control for equal test pulses in the Green channel. The Chroma control is set for desired mono/chroma ratio while viewing reflectance chart. See Figs. 11A and 11B. Refer to instruction book addendum IB-31843-1B.

Black and white balances are adjusted for best gray scale while switching color monitor from B&W to color. The reflectance chart should be correctly framed with the arrow heads just touching raster edges. Do not put the white chips at the extreme edges of the raster.

Use only Iris and Black Level controls to operate camera on scenes while viewing a *correctly set up color monitor*. Read the manufacturer's instruction book. The camera controls are adjusted for best picture—*NOT most pleasing waveform*. If camera head has been correctly set up, video level will not be a problem.

The White Level control is a set up control, not an operating control.

Calibrate the color monitor (must be one with a clamped black level) brightness control by, first, setting

the camera Black Level control so that, viewing color output on the CRO, black level is just above clipping. Then set monitor Brightness control so that black is just visible. Camera black level control can now be set for best picture viewed on monitor.

Modifications and technical bulletins are designed to improve your camera performance; therefore, they should be fitted as soon as practicable once the information is received.

One final point—*do not* “screwdriver” the camera head every day. It is neither desirable nor necessary. However, as pickup devices age they will require slight optimizing, so correct *just* the relevant parameters, e.g., gain, target, focus as necessary.

## Encoder

Color bars should be periodically checked. Always be sure that the “Color” position of the CRO output of the auxiliary is *identical* with the Color Blanker output. This is best done using a coax feed to a scope with 75 ohm termination at the scope.

When setting I and Q gains (Chroma), it is advisable to do this with a scope directly on the Color Blanker output, with a 75 ohm termination at the scope. *Do not* use a coax cable 1:1 probe on one of the blanker test points.

*Note that although there is a set-up difference, the video amplitudes (black chip to white chip) are equal.*

FIG. 11A M channel.

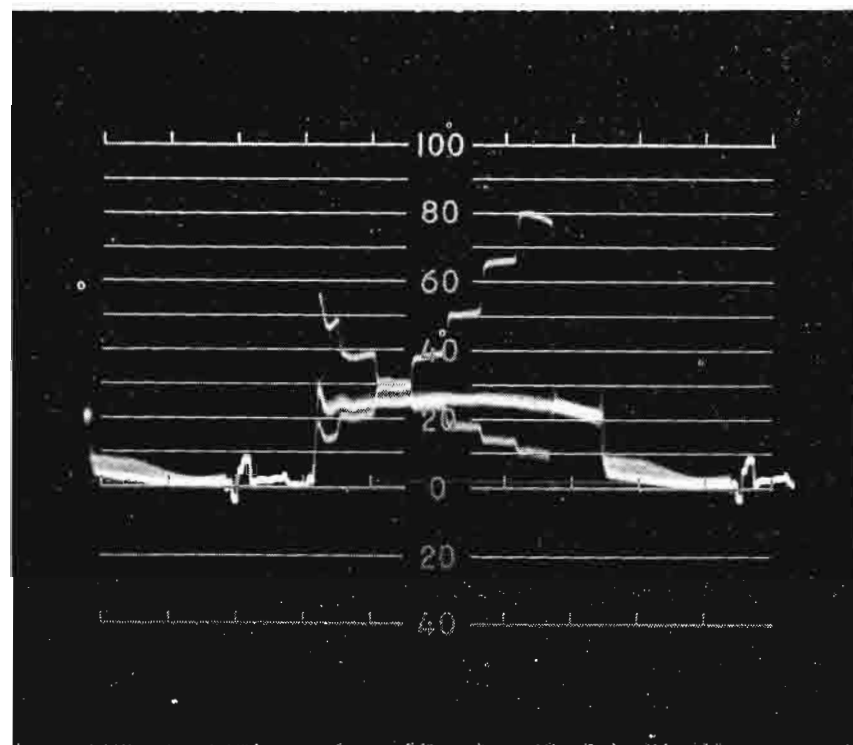
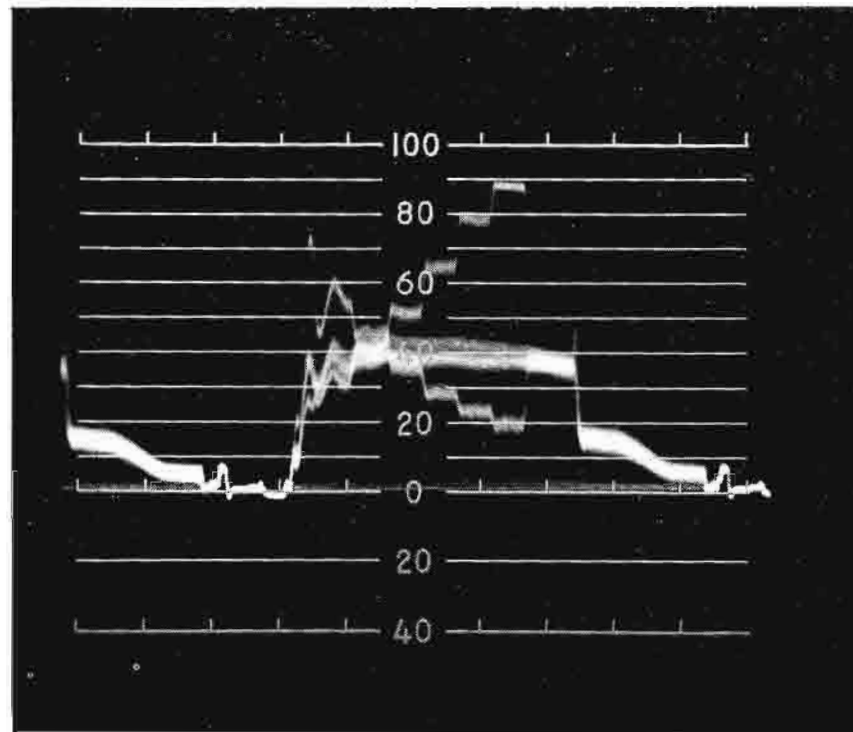

FIG. 11B G channel.



# Products in The News



## Solid State Film and Slide Multiplexer

Integrated circuits, logic control and new methods of image switching are key features in a new TP-55 Multiplexer now available to replace the TP-15.

The new TP-55 provides optical switching between a TK-27 Color Film Camera, TK-22 Vidicon Camera, TP-7 or TP-77 Slide Projector and two TP-66 Film Projectors. The TK-22 is mounted inside the housing and the slide projector is on a pedestal on top the multiplexer.

Extensive use of integrated circuits and logic control techniques does away with scores of relays and switches, reducing maintenance and greatly improving the reliability. The unique method of mirror switching is a vertical wiping action which minimizes mirror movement, eliminates dark intervals and makes optical transitions invisible. There is mounting space in the multiplexer for accessory equipment in addition to the TK-22 camera. All connections are available on a push-on terminal block.

The new multiplexer retains all the advantages of the TP-15 such as preview of one film while another is on the air, remote control of projectors and dual channel changeover.

## FET Preamp Kit for TK-27 Cameras

A Field Effect Transistor (FET) Preamplifier Kit previously offered only on a limited test basis will soon be available to all TK-27 Film Camera users.

The Kit includes an 8480-V1 luminance vidicon, which, due to the superior characteristics of the FET, will operate at half beam current. The main advantages of the kit are improved target tracking in the luminance vidicon and a significant increase in tube life.

For ease in ordering, an MI-557234 has been established for the tube kit combination. The price is \$1,140, and includes a new 8480-V1 tube and the FET Preamp Kit. General deliveries of the kit will begin in June.

## Optimize Tape Heads In Seconds

TR-60 and TR-70 owners are finding out that the 20 or 30 minutes it may take to optimize head record currents can be pared to less than 30 seconds in their new machines. This is the result of an innovation in the FM test facility.

A new Record Current Optimizer gives the operator an instantaneous CRO display of the response of each head as he varies the record currents. To activate the RCO, it is only necessary to press the master record and test mode switches simultaneously. This automatically reduces the capstan speed to provide a condition whereby head #2 reads out head #1 recording, etc. Head readouts appear in sequence, so each channel can be optimized in far less time than with the old trial and error method.

While head optimizing is something that is done more or less frequently depending upon the rate of head wear, this new test is so fast and accurate that it is practical to optimize heads for best performance on every new tape used.

The Record Current Optimizer is built into the TR-70B Tape Recorder, and it is an available accessory for the TR-60 and earlier TR-70 series recorders.



## First Highband Color Test Tape

A 525-line, highband color test tape is now available as an aid in checking and maintaining video tape machine performance. The new test tape can be used to evaluate any recorder having SMPTE or EBU video pre-emphasis characteristics, regardless of make. A 625 PAL version will be available in mid-1969.

The tape contains four separate test signals—multiburst, ramp with carrier, 2T and 20T pulse and bar, and 75 per-

cent saturated color bars. The first two minute length of tape contains 30-second segments of each of the test signals, and is primarily intended for a cursory check of daily setup adjustments. All the signals are repeated in the following eight minutes of tape.

Signal lengths in this last segment are:

Multiburst .....1 min., 30 sec.  
 Ramp with Carrier (625 line test tape  
 contains stairstep with carrier) .....2 min., 30 sec.  
 2T and 20T Pulse and Bar .....1 min., 30 sec.  
 Color Bars .....2 min., 30 sec.

Quality control applied to the test signals recorded on the tape, and the attention given to detail in production assure a high degree of uniformity between tapes produced at different times.

The various test signals may be used as follows:

*Multiburst*—100% modulated bursts may be used to check head channel equalizer settings and to check video level and response adjustments throughout the machine.

*Ramp With Carrier*—This test signal may be used to check the differential gain and phase performance of the machine.

*2T/20T Pulse and Bar*—This test signal may be used to check amplitude versus time response (K rating) as well as indicating the luminance/chrominance time and amplitude inequalities.

*Color Bar*—This test signal will prove machine performance to seventy-five percent saturated color bars and will provide a subjective evaluation of total color performance.

Each of the signals recorded on the tape are recorded with a color burst on the back porch of the TV signal, insuring that machine error correcting circuitry is activated, and at the same time making it possible to develop servicing and maintenance adjustments of the error corrector circuitry using this test tape. The new test tape will become a common standard of reference for high quality test signals.

The 525-line domestic tape is ordered as MI-41699. The price is \$300. When the 625 PAL version becomes available, it can be ordered as MI-41698.



### New Lightweight Pickup Arm

Extreme light weight and low inertia are achieved in a new broadcast turntable pickup arm, Type BDR-1, by a completely "integrated" design. The pickup arm, cartridge and stylus are designed together as a system.

The result is a pickup with a vertically and laterally balanced, very low mass arm. The low resonance frequency assures tracking of warped discs. A built-in guard prevents stylus damage in case the arm is dropped.

The arm also features fixed anti-skating, precision instrument ball bearings, and a complete selection of quick change stylus assemblies.

The BDR-1 cartridge is a four terminal device. In monophonic use, the left and right outputs are paralleled. Provision is made for insertion of an electrical signal for testing the system, which eliminates the need for test records except for checking the stylus assembly. There are no balancing adjustments to be made or to get out of order.

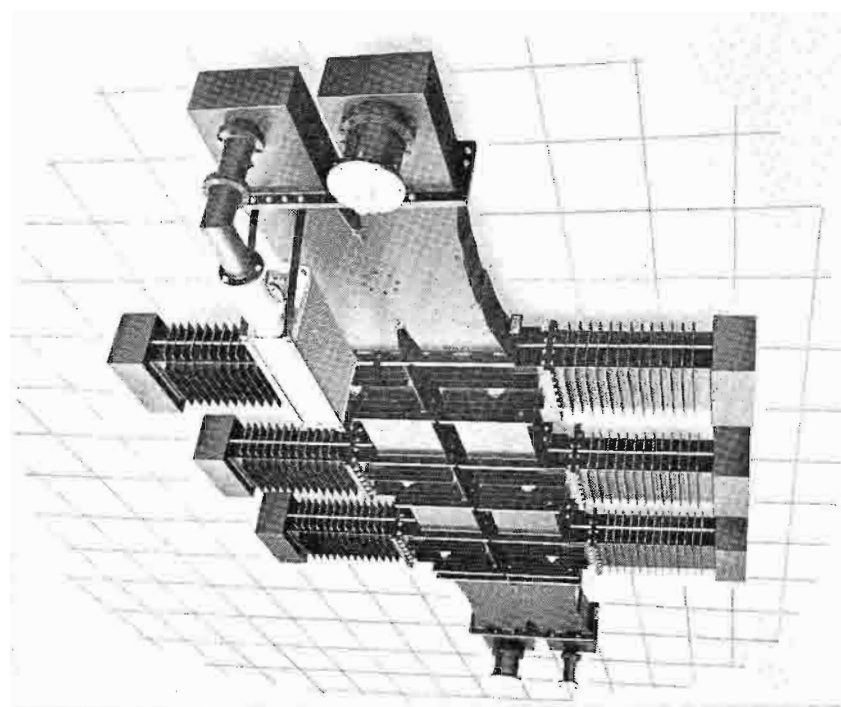

### High Power Waveguide Filterplexer

A new ceiling mounted waveguide filterplexer is being supplied with RCA 60 and 110 kW UHF transmitters.

The single unit diplexes the picture and sound signals, while at the same time shaping the transmitter output waveform to meet FCC vestigial sideband TV standards. Two waveguide sizes serve the entire UHF band. Visual channel efficiency is approximately 97 percent.

No gassing or pressurization is required. Cooling for the 60 kW and Channel 14 to 42 110 kW version is by free convection enhanced by a special cavity-fin design.

Aluminum construction achieves high conductivity and minimum weight, making the unit ideal for overhead mounting and saving valuable floor space. Filterplexer size, of course, is determined by the channel.

### High Power UHF-TV Coaxial Line

A new Teflon  $8\frac{3}{16}$ -inch Universal Coaxial Transmission Line is now available for high power UHF TV installations.

The new 75-Ohm line, with a typical efficiency of 84.9 percent for an 800 foot length on Channel 35, handles over 100 kW of TV power up through Channel 56, and achieves the maximum five megawatts ERP with the RCA Polygon Antenna and TTU-110A Transmitter. Specific power ratings

are in terms of peak visual power with 20 percent aural power, and vary from 135 kW at Channel 14, to 105 kW at Channel 56. Typical efficiencies and power capabilities for selected channels and line lengths are given in the accompanying table.

The line is available in both 19½ and 20 foot lengths and includes 90-degree elbows, fixed and expansion hangers and other accessories. Estimated component delivery time for a 1,000 foot system is presently 15 weeks.

### 8 <sup>3</sup>/<sub>16</sub>-INCH UNIVERSAL TRANSMISSION LINE—POWER AND EFFICIENCY

Channel	DB Loss Per 100 feet	Length in Feet				Peak TV Power Capability
		800	1000	1200	1400	
35	0.0889	84.9%	81.5%	78.2%	75.1%	118 kW
40	0.0911	84.6%	81.1%	77.7%	74.6%	114 kW
45	0.0932	84.2%	80.7%	77.3%	74.0%	111 kW
50	0.0954	83.9%	80.3%	76.8%	73.5%	108 kW
56	0.0978	83.5%	79.8%	76.3%	73.0%	105 kW

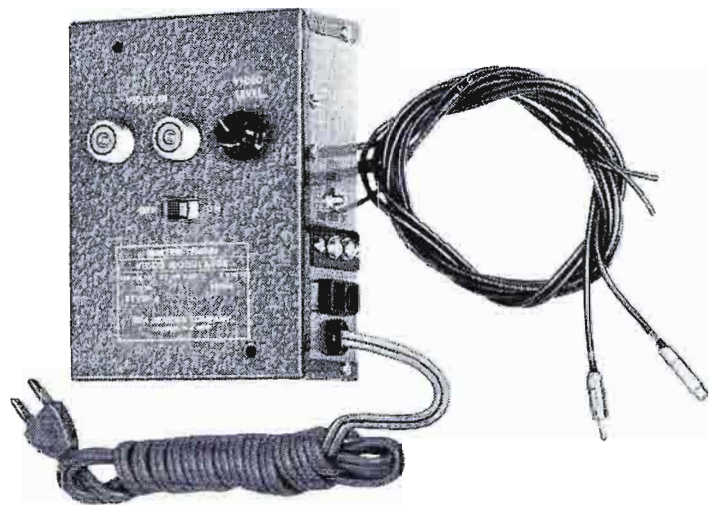

### Modulator Converts TV Receiver To Picture Monitor

A new Video Modulator, Type ETVM-4, converts any black-and-white or color TV receiver to a monitor for display of video signals.

The self contained, all solid state unit feeds picture and sound signals from a video and audio source into the 45 MHz I-F system of the receiver. A single switch controls the ETVM Modulator. When it is turned on, the receiver acts as a picture monitor with full control of audio by the receiver volume control. When the switch is off, the TV receiver operates normally from its own antenna system. Re-alignment of the TV receiver is not necessary and video compensation is not required when the ETVM-4 is used.

No changes are required in the TV receiver circuitry to use the Video Modulator. Simple connections permit quick and easy installation. The unit with its self contained power supply is mounted in a compact metal case only 4½ by 5½ by 3 inches.



### Pneumatic Camera Pedestal

A new easy-handling Houston Fearless camera pedestal, Type TD-8, is now in stock and ready for immediate shipment. It is an ideal companion for the TK-44A Color Camera, but it is quickly and easily balanced to match any camera and lens combination.

Counterbalancing is achieved by a pneumatic system which does away with the usual heavy lead weights, greatly reducing floor loading and increasing maneuverability. Mechanical drag may be adjusted to suit the operator. This convenience also eliminates the column brake and its cumbersome electrical connections. Dual wheels and an adjustable cable guard provide the greatest handling ease. Better, steadier pictures result from the smooth vertical travel of the column and the stabilized mounting.

### “Frost Sensitive” De-icer

A new type of de-icer, which is activated by ice forming on the antenna structure, lights a warning signal in the transmitter room and energizes a contactor to apply power to the antenna heaters. Low temperature alone will not activate it, and the device will not give a false ice-warning signal when coated with water, oil, dust or other foreign matter.

Most ice warning and heater control systems are operated by a thermostat which energizes the antenna heaters continually as long as the temperature is below 35 degrees F, whether or not ice is present. Since statistics indicate that ice is present only a very small percentage of the time, the frost-sensitive device reduces deicing power costs and extends heater life.

The ice warning and control signal output is 115 Volts at 60 Hz, limited to a current which is used to activate the contactor. Special circuitry turns the system off when the ice disappears, and re-cycles it for future icing conditions.

Equipment consists of an ice detector which is mounted on the antenna structure, and an ice detection controller which is mounted in the transmitter room. There is no restriction on the length of the cable connecting these two units. A 115 Volt, 60 Hz power source is required for operation of the ice warning system.

### Mail Order Module Repair Service

Owners of TK-22 and TK-27 film cameras are urged to take advantage of RCA's repair program for any module that becomes defective in these film cameras.

The service is quick and easy to use. Just determine the exact MI-number of the module you need and give this information to Al Freedman in Camden at Area Code 609-963-8000. RCA will air-ship a replacement module to you with an authorization for return of the defective module. You then ship the defective module to RCA Service Company. Please be sure to specify if your cameras are still under warranty.

Of course, boards damaged beyond repair cannot be accepted for exchange. Also, the customer is required to return the defective module within 24 hours.

The charge for each module exchanged is only seventy-five dollars, which in most cases saves the station both time and money.

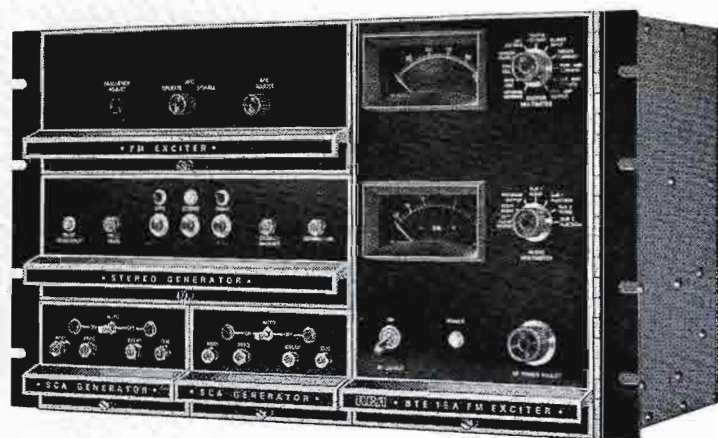

### New Solid State FM Exciter With Signal Metering

The latest Direct FM Exciter is the BTE-15A featuring extensive integrated circuitry and expanded instrumentation.

One of the many important advantages is the provision of two front panel meters. One of these checks all the DC test points. The second meter is an audio voltmeter that gives peak readings on modulation levels. This results in meaningful indications for program material such as voice, where the usual multimeter would show only an RMS, or average, reading.

The new exciter also has automatic switching between stereo and a subcarrier generator at 41 kHz if this second SCA unit is used. The stereo and two subcarrier generators

are all plugged into the exciter frame. Pressing the stereo pushbutton automatically cuts off the 41 kHz subcarrier generator. It doesn't matter which positions the 41 kHz and 67 kHz units are plugged into, since they are interchangeable.

Switching between mono or stereo left and right can be accomplished without any change in audio level. Thus, in case one stereo program line fails, full modulation can be maintained by pressing the button corresponding to the remaining program line.

Output power is easily adjustable. A single knob on the front panel varies power output from a low of five Watts to a guaranteed high of at least 15 Watts. The knob simply controls the DC voltage to the transistorized amplifier. Changing power requires no retuning.

Owners of a BTE-10C Exciter can pull the unit out and install the new BTE-15A Exciter with its stereo and two subcarrier chassis in the same space. The new exciter is completely interchangeable, even to the plugs on the back.

### New Broadcast Audio Amplifier

A new solid state, 50-Watt plug-in amplifier is now available for use with disc pickup, tape recording, telephone line sources and the audio channels of broadcast transmitters.

The new amplifier, Type BA-48A, produces 50 Watts RMS, with or without optional output transformer, with total harmonic distortion of less than 0.5 percent from 20 to 20,000 Hz. The unit is completely stabilized for temperature.

Solid state components result in a compact unit with simple circuitry, low heat dissipation and much lower power consumption. Complete protection against damage from open-circuits, short-circuits and overloads is provided. Transformers are internally shielded against hum radiation or pickup.

The BA-48A is designed for convenient plug-in installation in the BR-22 Mounting Shelf which will accommodate two of these amplifiers. Accessories include remote gain control module, input, bridging and output transformers.

### Calibrated Color Control Knobs

New detent knobs available in kit form for the TK-27 and TK-42 cameras provide calibrated control of RGB color balance, allowing the operator to quickly and accurately return to zero setup after "painting" the controls for special films or studio scenes.

Each detent represents approximately a one-percent change in color balance. The dials are adjustable so that zero positions may be indicated for any settings of the three knobs.

The kit may be ordered as MI-557815 and consists of the three detent knob assemblies plus two sets of dial faces by which calibration markings can be made to appear either at the top or bottom of each control. Also included is a special installation tool. Assembly time is about 30 minutes.

## 4 NEW LOW-COST COLOR CAMERAS WIDEN ETV AND CATV HORIZONS



Introduced at the 1968 NAEB Convention, a four-some of new budget-priced cameras are expected to have far-reaching effects on the utilization of color TV for education, industry, CATV, and other closed-circuit applications.

### Single-Tube Color Cameras

Priced from \$6500 to \$9850 the live cameras include viewfinder and non-viewfinder models along with a complete color film system. Key to the low price is an entirely new concept in camera design. A single pick-up tube, in combination with a special color-detecting optical filter and innovative electronics, produces faithful color rendition and eliminates registration problems. The tube is a standard vidicon.

Fast warm-up and simplified operation are other features of special interest to closed-circuit users, where technicians are not always available. The cameras are ready for "on the air" operation in five minutes or less, which is somewhat faster than conventional multi-tube color cameras. Only five controls are required, about the same as comparable black-and-white cameras.

### 3-V Color Film Camera

A new 3-vidicon film camera, Type PK-610, makes color practical for even the smallest broadcast stations. Combining performance and economy, the camera is priced at less than one-third the cost of standard broadcast color film cameras. A full complement of controls permits precise operation with sparkling, vibrant colors and crisp, pleasing pictures.

Not much larger than many black-and-white film cameras, the PK-610 may be used with most existing film systems and multiplexers. This makes it especially practical as a primary film camera in small-market stations or for backup use in larger installations.

Many features have been included to simplify set-up and operation and to provide consistent picture quality. Registration is reduced to "touch-up", since the entire optical system is permanently mounted on a heavy-duty baseplate and sealed for protection against dust and dirt.



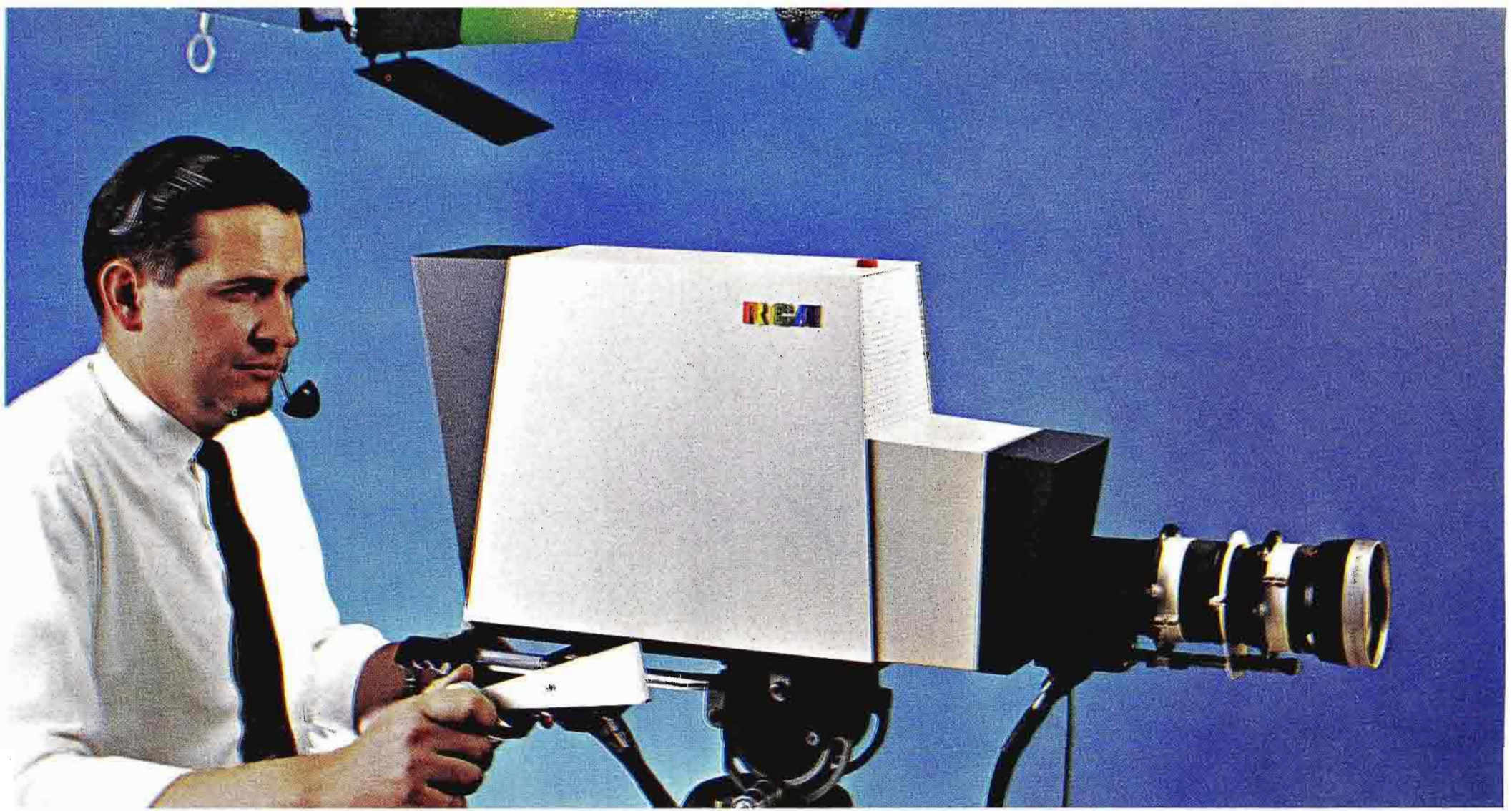

FIG. 1 New single-tube solid-state live color camera, Type PK-730. This is a viewfinder camera with 6:1 zoom lens.

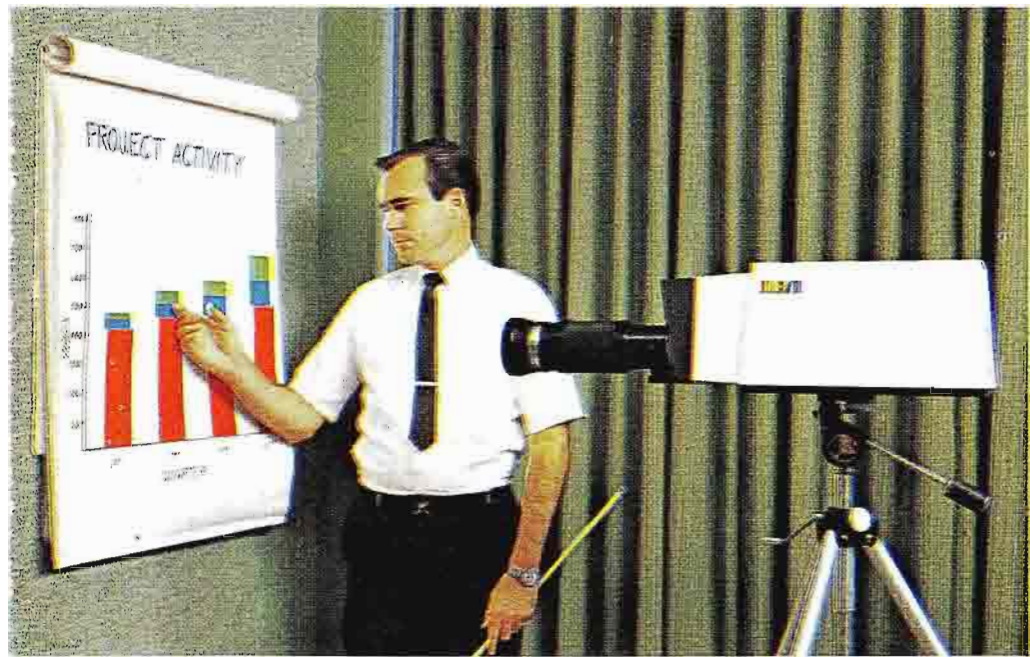

FIG. 2 Type PK-701 color camera is essentially the same as the PK-730—but has no viewfinder.

FIG. 4 New 3-vidicon solid-state color film camera, Type PK-610. It may be used on many different film systems. Selling price is \$14,750.

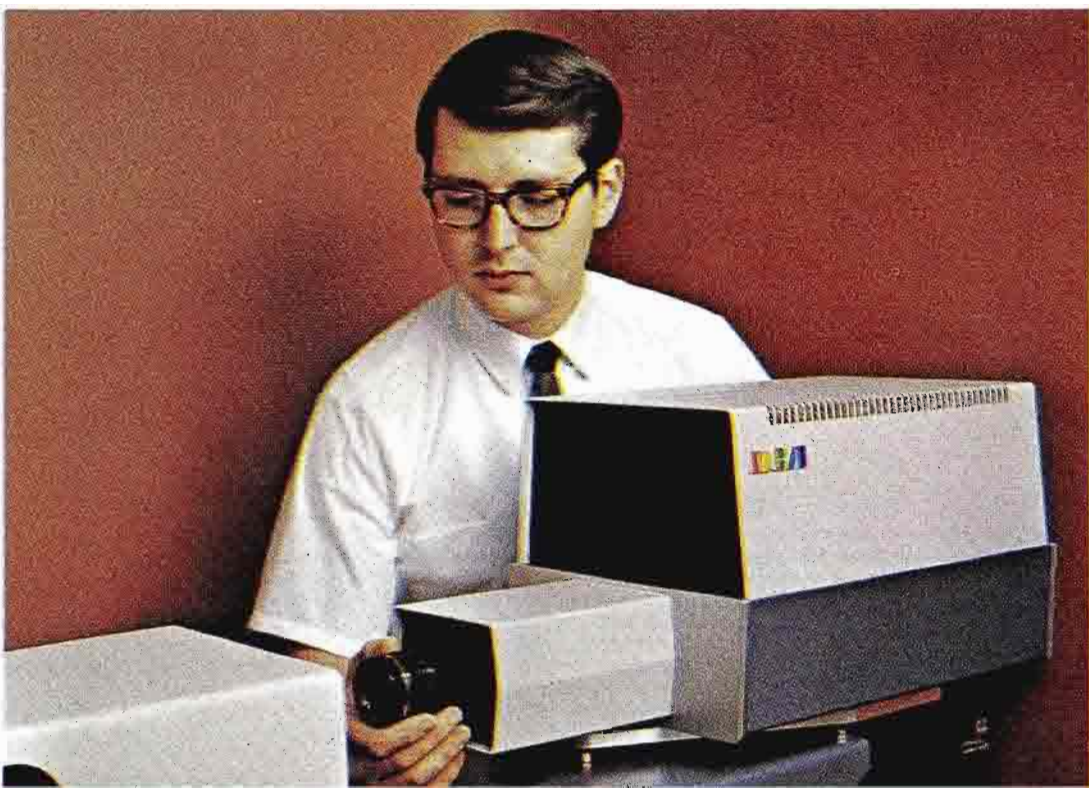

FIG. 3 New low-cost color film system, Type PFS-710, includes a single-vidicon color camera. It's a completely self-contained system, including multiplexer and projectors. Selling price is \$9850.



# The NEW RCA 70B is the first VTR to safeguard quality automatically!

In many ways, the 70B can make the VTR operator feel he has more command of tape quality than ever before. Because he can get the highest color fidelity ever achieved—with the most reliable automatic instrumentation ever devised for a VTR.

**Automatically**, the 70B eliminates costly replays. Sensing circuits just won't let you play tape on the wrong FM standard. Instead, the proper playback standard is selected for any tape—highband, lowband monochrome or lowband color—automatically.

**Automatically**, the 70B pinpoints problems through its visual-audible central alarm system and alerts the operator immediately.

**Automatically**, the 70B can save your operator time by eliminating the need for manual cueing. Now he can pre-cue several tapes so they are ready to roll automatically—eliminating tension during the critical station break period.

**Automatically**, the 70B can eliminate saturation and hue errors. Use the RCA exclusive Chroma Amplitude and Velocity Error Corrector (CAVEC), and the 70B will not only correct chroma errors between bands—but between each line of a band as well!

**Automatically**, you get better color. The 70B has broadcasting's highest specs—K factor of 1% with 2T and 20-T pulse; differential phase and gain 3° and 3%; moire down 43 db and S/N of 46 db.

The RCA 70B is the dream VTR come to life. For all the reasons why, call your RCA Broadcast Representative. Or write:  
RCA Broadcast Equipment, Bldg. 15-5, Camden, N.J. 08102.

# They won't shut up because they won't shut down

**After 23 years of designing and installing microwave, 95% of all RCA-equipped stations are still going strong.**

RCA microwave just never seems to wear out . . . and we have 23 years of operating experience and thousands of microwave stations to prove it. From small one-hop systems to cross-continent, high density networks, RCA microwave is an around-the-clock performer—transmitting voice, data, telemetry and supervisory control signals.

And it's 23 years better today. That's because today's RCA microwave is total solid state design (an RCA first), which means no tubes to burn out and no relays to fail. Heterodyne operation (RCA pioneered that, too) brings in clear signals, eliminates distortion.

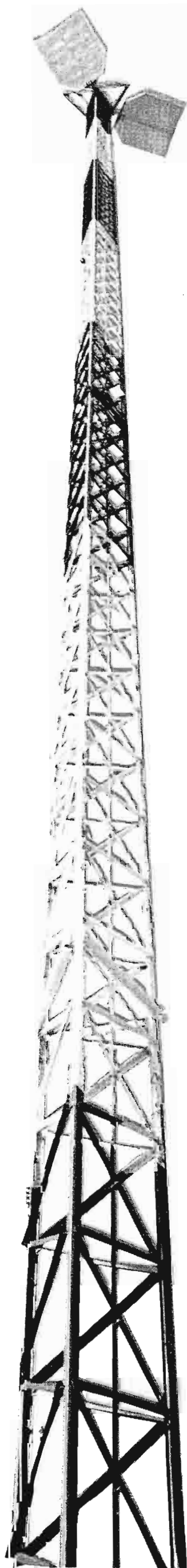

If you are planning a microwave system, shouldn't you look into RCA microwave? Send for literature, or better still, request a planning consultation with an RCA microwave expert. He will show you what a difference 23 years of experience can make. Write RCA Microwave, Dept. K-475, Bldg. 15-5, Camden, N.J. 08102.

**Here are just a few leading organizations who rely on RCA Microwave:**

**American Electric Power  
California Division of Highways  
Chicago & North Western Railway  
El Paso Natural Gas  
Empire District Electric  
Los Angeles Police Department  
Santa Fe Railway  
Shell Oil**

# One-of-a-kind antenna system takes unique skills

You couldn't ask for a more complex TV antenna system than this one-of-a-kind installation—with five RCA antennas on-air from twin masts on John Hancock Center in Chicago next fall. Only the Empire State antenna system by RCA paralleled it in technological involvement.

The John Hancock Center has: Two UHF Polygons. A VHF Zee Panel. A VHF Superturnstile. A VHF Butterfly. Each one is designed to handle maximum authorized ERP. All five can radiate maximum power with minimum inter-reaction. And that's not all: There are provisions in the system for future expansion to a total of 10 antennas!

Did you know that almost all multiple antenna installations in the business were RCA-engineered—planned—tested—built—and installed? And that the basic principles of multiple array antenna operation were first evolved at RCA's Gibbsboro Center—world's best equipped and most advanced Antenna Engineering facility. Or that Gibbsboro maintains the industry's largest and most complete computerized store of reference data. RCA's experience and intelligence are readily adaptable to solutions of every kind of antenna problem.

Your antenna is your bridge to business. Call your RCA Broadcast Representative when you begin to think about that installation. Or write RCA Broadcast and Television Equipment, Building 15-5, Camden, N.J. 08102.

Owner/Developer:  
John Hancock  
Mutual Life  
Insurance Company

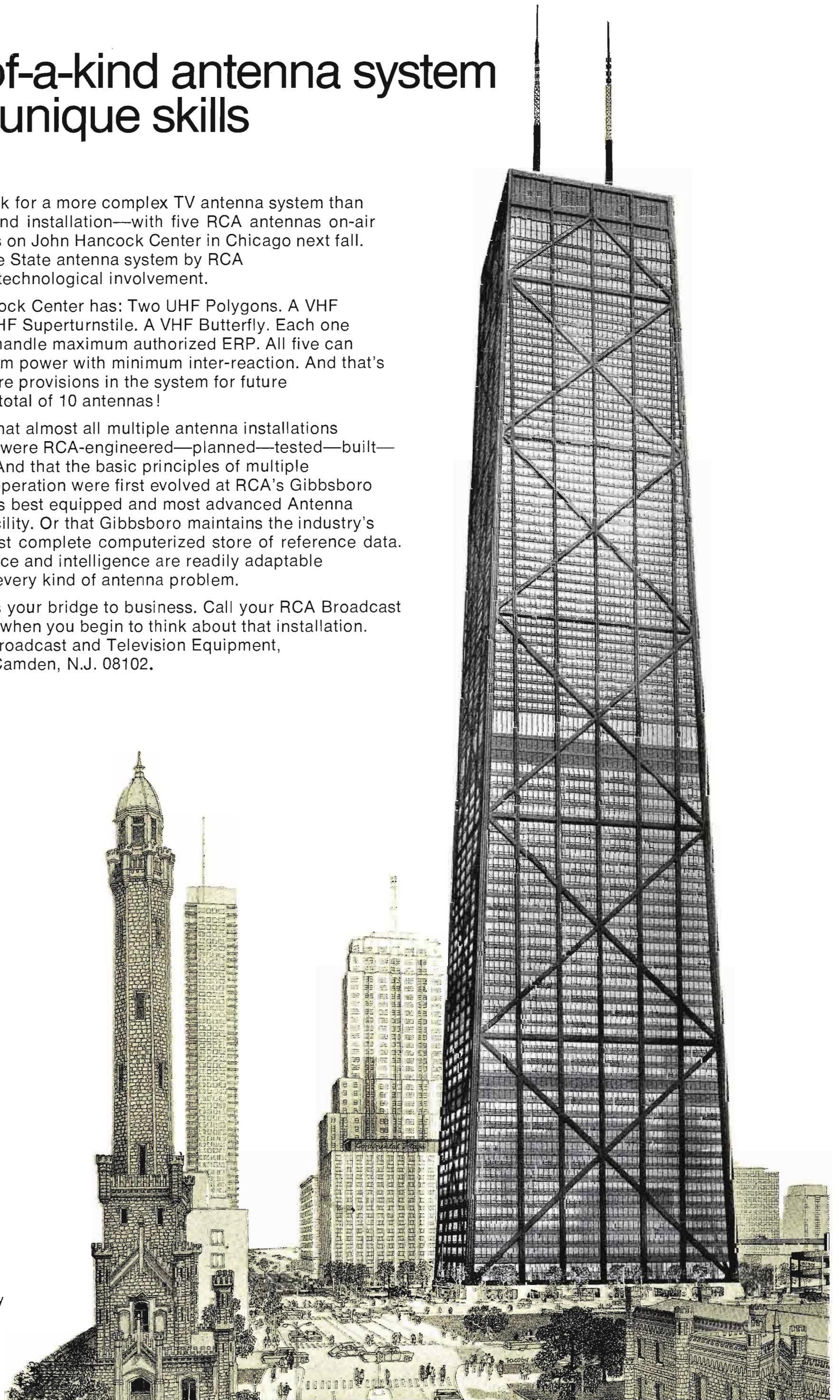

...100%  
transmitter  
redundancy...  
100%  
transmitter  
standby...

Off-air time—even just when switching from main transmitter to standby—is one budget-spoiler that parallel operation can take care of once and for all. Our parallel VHF-TV's have been logged at 150,000 hours of combined operation—with less than 60 minutes off-air!

But that's only one of the budget advantages of parallel operation.

**Consider initial cost.** If you bought a 25KW main and a 25KW standby, you would invest about \$279,000. Reduce the standby power to 12.5KW and you would still spend about \$245,000. But a pair of RCA transmitters—parallel mains for 25KW—cost only about \$237,000.

**Consider day-to-day costs.** In many areas, operating costs, maintenance costs, power costs, tube costs all drop markedly. (See new brochure for substantiating data)

**Consider performance.** Parallel operation assures 100% redundancy for full-time dependability. By diplexing two transmitters you gain a standby "hot" exciter that is ready to go when needed. And, of course, with RCA transmitters you deliver superior monochrome and color pictures all the time.

We've worked out a number of standard packages that meet most of the standard requirements. For low-band systems, we offer parallel 6KW, 12.5KW, or 15KW's. For high band, channels 7-13, we offer parallel 5KW, 12.5KW or 25KW systems.

As soon as you're ready for "paralleling", call your RCA Broadcast Representative. Or write for our new brochure to RCA Broadcast Equipment, Bldg. 15-5, Camden, N. J. 08102.



ON AIR ON AIR ON AIR

ON AIR

ON AIR

ON AIR

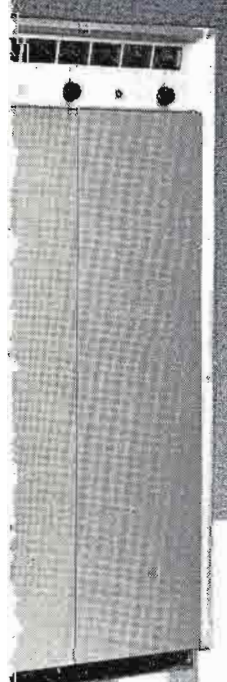

ON AIR ON AIR ON AIR

ON AIR ON AIR ON AIR

# Relia- bility...

**the long-term "extra" with Super-Carfone/500**

Here's a 2-way radio designed with one goal in mind. Reliability. RCA engineers designed in components that can take it and are built to get the best performance out of every section of the radio.

Consider. All transistors in the transmitter/receiver are the silicon type. They withstand heat almost indefinitely without deterioration or loss of stability.

Temperature compensated crystal oscillators keep the radio always on frequency. No frequency drift even from "cold" start-ups.

And it's the first complete line of 2-way radio equipment to use an integrated circuit. Inherently more reliable. Eliminates some 30 components and 120 soldered



connections. Nobody else is that far ahead.

Better reliability combines with better performance to bring you a better 2-way radio. The Super-Carfone/500 is available in all frequency bands and in a wide range of powers. With up to four frequency operation. And for convenience, a one unit speaker and control panel. Compact. Smart looking. One less unit to clutter the cab.

Ask your RCA Communications Specialist for the full Super-Carfone/500 story—how long-term reliability can make it your best communications investment ever. Or, for a detailed brochure, send your letterhead request to RCA 2-Way Radio, Dept. R-471, Bldg. 15-5, Camden, N.J. 08102.



When the man  
45° up and 120° across  
gets full-fidelity  
sound...

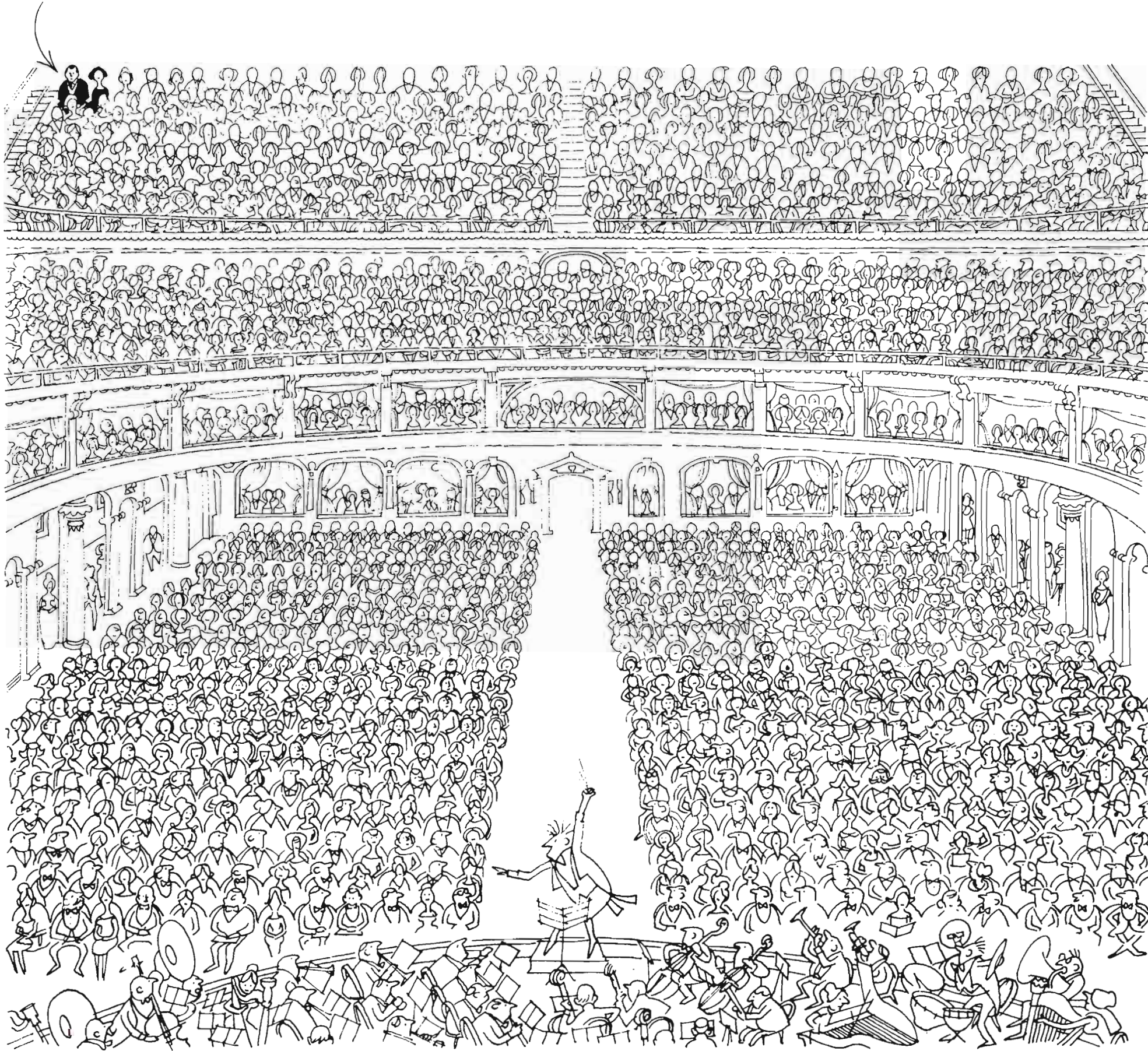

You'll be  
using this  
new RCA  
LC-9A speaker

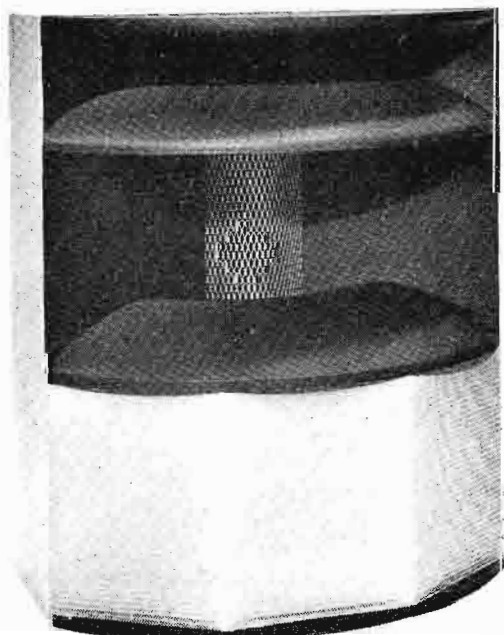

This new auditorium loudspeaker looks good, and sounds even better. It's a high efficiency speaker which puts the "obsolete" tag on thousands of sound systems—old and new.

The unusual thing about the LC-9A isn't the extent of its dispersion, the 50 watts power input, or the 32 to 22,000 Hz frequency response.

It's the way the high and low frequency horns provide matched acoustical wavefronts for smooth response over the entire frequency range at all listening angles.

Have your RCA Professional Audio Distributor demonstrate the LC-9A. Walk across the back of the room while you're listening. Then open a door, and listen from further out. It'll get to you. It'll get to your clients and their audiences, too.

# RCA service keeps all your AM, FM, TV equipment in top condition

## TAKE ADVANTAGE OF THE FOLLOWING SERVICES OFFERED BY RCA:

- Video Tape Recorder Service • TV Camera Overhaul
- TV Transmitter Overhaul • Installation Supervision
- Microphone and Pick-Up Repairs • Transmitter Performance Measurements • Antenna Inspection Measurements
- Console Repairs • Microwave Service • TV Projector Service
- Custom Fabrication • Teletypewriter Maintenance

Your audience demands a superior signal which requires top performance from all your station equipment. RCA Broadcast Service is planned to assure you of meeting this objective. More than 30 years in the broadcast industry have provided a background of solid service experience. This is the type of protection broadcasters have relied on for years, the kind of protection you can count on . . . contract or per-call . . . from the experts in the service business, RCA Service Company. To guard performance of all your equipment . . . simply telephone one of the following field offices: Chicago (WE 9-6117), Phila. (HO 7-3300). Or contact Technical Products Service, RCA Service Company, A Division of RCA, Bldg. CHIC-225, Camden, N. J. 08101.





So what's new  
about a 3-tube  
color camera?

This . . . we made  
it better to  
suit your needs

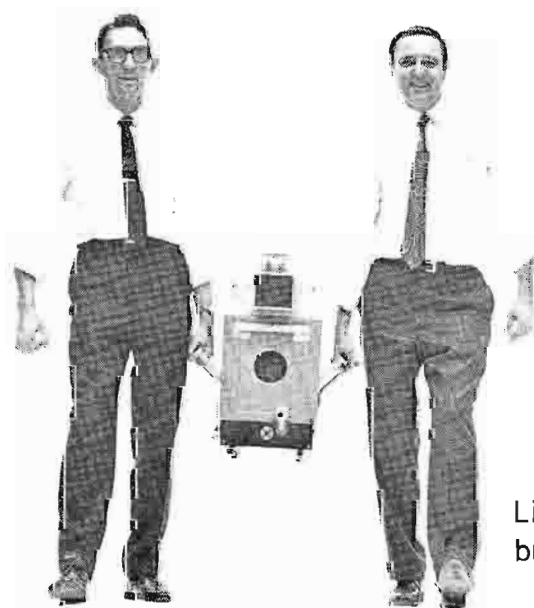

Lightweight . . .  
built to travel.

The new TK-44A. It's the latest design in 3-tube cameras. It uses RCA's exclusive "contours with a comb" that produces snappy, brisk color without raising the noise level. It's lightweight, easily toteable from studio to field, extremely maneuverable under all conditions.

The TK-44A can color match any color camera you may own. It delivers NTSC color with greater accuracy than any other PbO color camera available today. The reason: a unique "Chromacomp" color masker.

Get the facts on all the features that mean better color, more time for operators to spend thinking instead of tinkering, less tension, and greater efficiency indoors and out!

The new TK-44A. It just might be the color camera for you.

**RCA** Broadcast  
Equipment

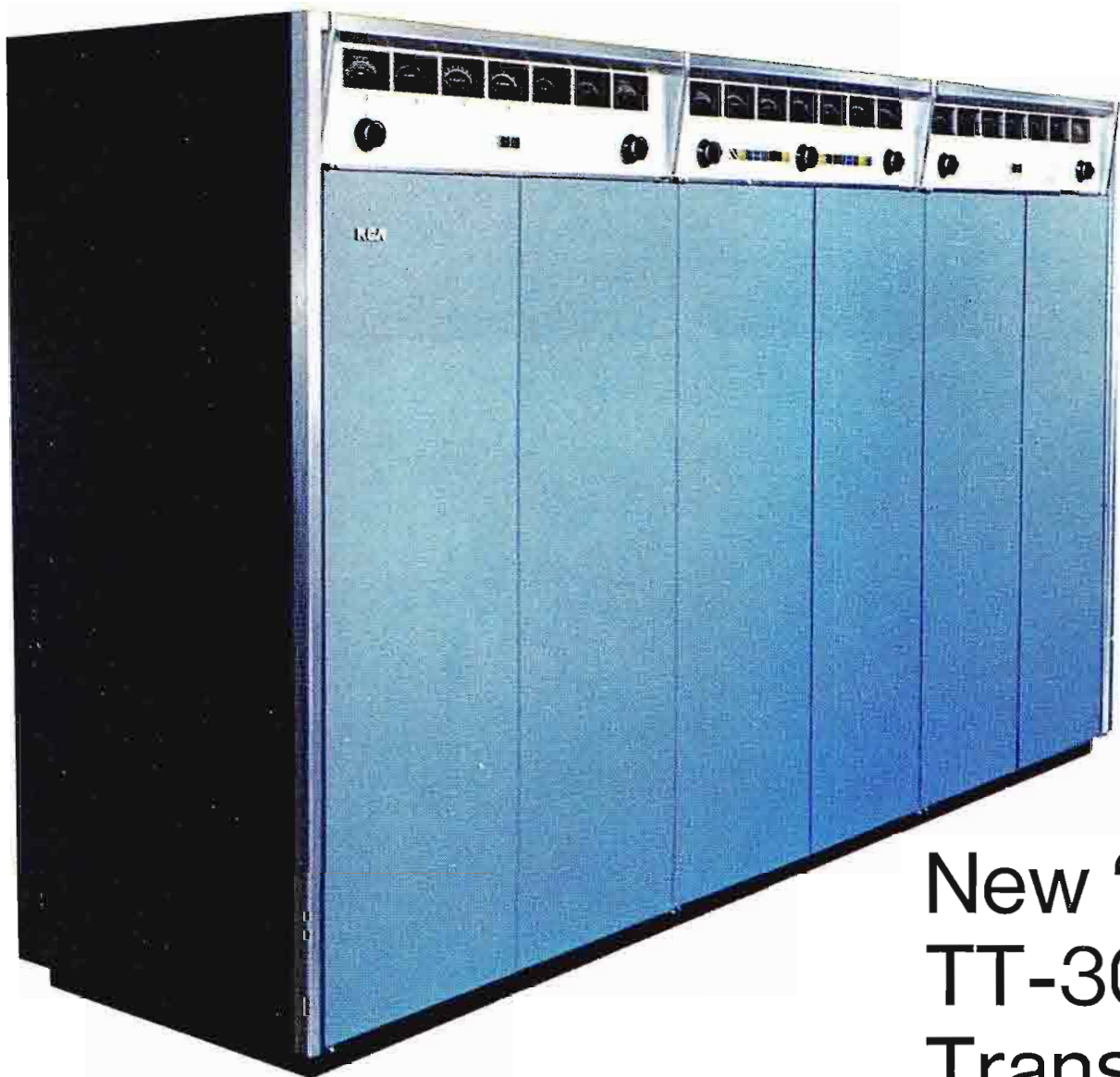

## New "Maxim-Air" TT-30FL VHF-TV Transmitter

Better Performance . . .  
182 Less Tubes



The "Maxim-Air" . . . the VHF transmitter of the future . . . available today. This 30-kW transmitter is designed for solid-state operation . . . and will provide the best color signal in town. Color that captivates your audience from a futuristic transmitter that just won't quit . . . that's what "Maxim-Air" is all about.

Imagine . . . almost no transmitter off-air time . . . what a savings!! The TT-30FL has two transmitters operating in parallel . . . if you lose one, the other keeps you on the air . . . and your audience in the primary coverage area can't see a difference. Also, redundant exciters . . . with automated switching that is unnoticed in case of a failure. But that's only part of what the "Maxim-Air" TT-30FL can do . . . the basic reliability is built into the high-quality solid-state design—where no corners were cut to achieve a sharp, clear, stable color signal. And only ten tubes have been used . . . ingeniously, at much less than their ratings. We've reduced the two most likely sources of failure—tubes and circuit compromises.

The "Maxim-Air" is far ahead of current transmitters. It has motor-driven controls and remote metering—is ready for full remote control and automatic logging . . . and is even ready for eventual computer control.

**RCA** Broadcast  
Equipment